

Integrity

Innovation

Accountability

Passion

Teamwork

OMNI 

Commitment

Quality

Competence

產品目錄
PRODUCT CATALOGUE
2018-19

Company Profile 公司簡介

Company background 公司背景

Omni Electrical & Lighting is wholly owned by Yatai International Corporation, which celebrates its 20th anniversary in 2016. Based in Asian with 100 thousand square feet world-class manufacturing facilities and thousands of employees, Yatai is one of the few names in lighting & electrical industry with capabilities in R&D, manufacturing, selling and branding under one roof.

歐麗電業母公司 - 亞泰國際股份有限公司至今成立已超過 20 年，一直扎根亞洲，面向世界，成為區內生產優質照明和專業電業產品的企業。除了擁有占地達 10 萬平方呎、數千名員工的現代化生產設備的廠房外，亦是亞洲少數電業品牌能做到研發、生產、銷售及品牌一站式管理，絕對傲視同群！

Vision statement 願景

To become one of the most trusted, pioneer Asian's world brand in electrical & lighting, as the leading supplier of safe, innovative, customer-centric, eco-friendly and superior products at affordable price.

成為亞洲區內世界級電工及照明品牌，作為業內領先供應商，提供安全、創新、以客為主、環保及大眾化的優質產品。

Core Value 核心價值

Yatai and Omni continue to evolve and expand its business while remaining true to their core value represented by the eight petals of Omni logo, namely: accountability, integrity, teamwork, competence, quality, commitment, innovation and passion to continuously satisfy consumer needs.

亞泰及歐麗本著其核心價值發展至今。而歐麗標誌上的八片花瓣，正代表了我們八個核心價值：問責，誠信，團隊合作，能力，質量，承諾，創新和激情，以不斷滿足消費者的需求。

Mission statement 營運宗旨

To create long-term benefits for customers by delivering excellent products, creating value and services to Asian countries through innovation and cutting-edge technology, state-of-art manufacturing facilities, professional teams and superior craftsmanship.

以卓越的產品及服務、創新及先進的技術、完備的生產設備、專業的團隊及優秀的工藝為亞洲區客戶帶來長遠的利益及增值。



Quality Assurance 質量監控

We value quality assurance a lot and put into action to obtain various certifications issued by worldwide professional authorities, including IEC, DAF by German, UL/FCC by US, Energy Star & CE by EU, JIS by Japan and 3C by China in lighting products. For electrical products, we are accredited by HKEP(S)R, BS1363A by UK, CE by EU, 3C by China, SS167 by Singapore, MS589 by Malaysia and IEC. Benefit from high level of QA system, Omni delivers trustworthy products with premium quality and safety standard.

我們非常重視產品及服務的質量，以國際級水平為標準，照明產品榮獲國際標準電工委員會 IEC、德國 DAF 實驗室、美國 UL/FCC、Energy Star、歐盟 CE、日本 JIS、中國 3C 等品質標準和認證，主要產品獲得全球超過 40 個主要國家認證。電工產品更榮獲香港 HKEP(S)R、英國 BS1363A、歐洲 CE、中國 3C、新加坡 SS167、馬來西亞 MS589、符合國際標準電工委員會 IEC 等權威認證，產品無論在質量及安全上都是無容置疑。

Innovation 創新意念

Innovation and new product development is our foundation strategy supported by enormous investment. To uplift the efficiency of R&D, we have 300 product engineers, 10 specialized testing laboratories for product function and environmental standard. Our factory is operating and managed by ERP system with up-to-date facilities to ensure all products attaining highest international standard. As a leading company in Asia, we have more than 300 patents in professional electrical low voltage power adaptors covering various areas of products.

我們在產品開發及創新方面投入大量資源，包括擁有設計工程師逾三百名的開發團隊，建立了十個專門的技術研發、性能檢測及環保檢測等專業實驗室，提升研發的成效。全廠採用 ERP 系統嚴格管理生產流程，並不斷投入和更新設備系統，使我們有能力在最快時間完成設計和發展新產品，令產品性能指標達到國際最高標準。在電工產品方面，歐麗擁有 300 多項專業低壓電源適配器的專利，涵蓋不同類別產品。

Awards and Endorsement 獎項及認證

- Asia Excellence Award 2012 , 2014 & 2016
- Roadshow Best Loved Brands Award 2014
- Registered supplier of HKSAR EMSD (No.:S0685)

- 榮獲 2012 , 2014 及 2016 年度亞洲卓越品牌大獎
- 榮獲 ROADSHOW 一路最愛品牌大獎 2014
- 為香港機電工程署註冊供應商 (No.: S0685)





Contents 目錄

LED General Lighting Series LED 一般照明系列

LED A Bulb LED A 形燈膽.....	P.01-02
LED Globe Bulb LED 球形膽.....	P.03-04
LED Candle Bulb LED 蠟燭燈.....	P.05-06
LED Pinlight LED 插拔管燈.....	P.07-08
LED Flat Lamp LED 簡約頂燈.....	P.09-10
LED TRIO 3-Colors Blub LED TRIO 三色燈.....	P.11-12
LED Red Bulb LED 紅燈膽.....	P.13-14

LED Industrial and Commercial Lighting Series LED工業及商業照明系列

LED T8 Tube LED T8光管.....	P.15-20
LED MR11 Spotlight LED MR11射燈.....	P.21-22
LED MR16 Spotlight LED MR16 射燈.....	P.23-26
LED GX53 Cabinet Lamp LED GX53櫥櫃燈.....	P.27-28
LED Panel Light LED 平板燈.....	P.29-30
LED High Power Bulb LED 高效能燈膽.....	P.31-32
LED Ultra Slim Downlight LED超薄筒燈.....	P.33-34
LED Integrated Recessed Downlight LED 一體化嵌入式筒燈.....	P.35-36
LED COB Track light LED COB路軌燈.....	P.37-38
LED High Bay Lamp LED 高樓底燈.....	P.39-40
LED Strip Light LED 燈帶.....	P.41-44

LED Outdoor Lighting Series LED戶外照明系列

LED Par Lamp LED 射燈.....	P.45-46
LED High Power Garden Bulb 高效能庭園燈膽.....	P.47-48
LED Weatherproof Light LED 防水燈.....	P.49-50
LED Weatherproof Fixture (Ultra Slim Linear Light) LED一體化纖巧三防支架.....	P.51-52
LED Weatherproof Flood Light LED 傳統防水泛光燈.....	P.52-54
LED Weatherproof Slim Flood Light LED 纖巧防水泛光燈.....	P.55-58

LED Area Lighting Series LED 區域照明系列

LED Street Light LED 街道燈.....	P.59-60
LED Road Light LED 公路燈.....	P.61-62
LED Area Light LED 區域燈.....	P.63-64

LED Emergency Lighting Series LED應急照明系列

LED Automatic Emergency Light LED 自動應急燈.....	P.65-66
Emergency Li-ion Battery 應急鋰電池.....	P.67-68
All-in-one Emergency Li-ion Battery Kit 一體式應急鋰電池套件.....	P.69-70

Electrical Product Series 電工產品系列

Safety Extension Sockets 安全拖板.....	P.71-72
13A British Standard Sockets 13A 英標插頭.....	P.73-74
Universal Travel Adapter 環球旅行轉插.....	P.75-76

Appendix 附錄

Symbol Index 標籤索引.....	P.77-78
------------------------	---------



- Up to 85% energy savings when compare to incandescent 比烏絲燈膽節能高達85%
- Mercury free 不含水銀
- Less heat emission 熱能釋出量低
- 20,000 Hours of average lifetime 平均壽命可達20,000 小時
- Classic design with gentle lighting, perfect fit with lampshade
外型經典，適用於家居燈飾，營造柔和光線

LED
Lite

LED A Bulb
LED A形燈膽



LED A Bulb LED A形燈膽



MODEL 型號	CT 色溫	LUMENS 流明	LAMP BASE 燈腳	CRI 顯色度	PACKING 包裝
LED A50 Bulb 燈膽 - 6W					
LLA50E27-6W-DL	6500K	500lm	E27	>80	48pcs/ctn.
LLA50E27-6W-WW	2700K	450lm			
LED A60 Bulb 燈膽 - 9W					
LLA60E27 / B22-9W-DL	6500K	800lm	E27 / B22	>80	48pcs/ctn.
LLA60E27 / B22-9W-WW	2700K	750lm			
LED A65 Bulb 燈膽 - 12W					
LLA65E27 / B22-12W-DL	6500K	1100lm	E27	>80	48pcs/ctn.
LLA65E27-12W-WW	2700K	1000lm			

MODEL 型號	CT 色溫	WATT瓦數	LUMENS 流明	LAMP BASE 燈腳	CRI 顯色度	PACKING 包裝
LED Dimmable A Bulb 調光A形燈膽						
LLA60E27D-9W-DL	6500K	9W	850lm	E27	>80	48pcs/ctn.
LLA60E27D-9W-WW	2700K		800lm			
LLA65E27D-12W-DL	6500K	12W	1000lm			
LLA65E27D-12W-WW	2700K		900lm			

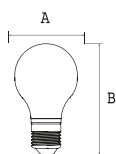

A Bulb A形燈膽		6W	9W	12W
SIZE 呎吋	A	50mm	60mm	65mm
	B	92mm	110mm	125mm
SRP 建議零售價 (HK\$)		\$ 25.90	\$32.90	\$ 43.90

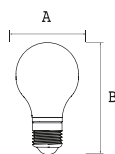

Dimmable A Bulb 調光A形燈膽		9W	12W
SIZE 呎吋	A	60mm	65mm
	B	110mm	125mm
SRP 建議零售價 (HK\$)		\$ 99.90	\$ 109.90

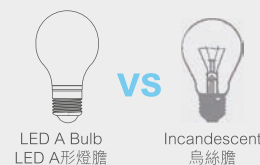

LED A Bulb
LED A形燈膽

Incandescent
烏絲膽

6W → 40W
9W → 60W
12W → 80W

IEC
62471

IEC
62560



20,000
Hours



UP TO
85%
ENERGY
SAVINGS

10
YEARS OF LIFE



LED A Bulb
LED A形燈膽



- Wide beam angle, illuminate any corner of the home 廣闊發光角度，照亮家居每個角落
- Up to 85% energy savings when compare to incandescent 比烏絲燈膽節能高達85%
- Mercury free 不含水銀
- Less heat emission 熱能釋出量低
- 20,000 Hours of average lifetime 平均壽命可達20,000 小時

LED
Lite

LED Globe Bulb
LED 球形膽



LED Globe Bulb

LED 球形膽



MODEL 型號	CT 色溫	LUMENS 流明	LAMP BASE 燈腳	CRI 顯色度	PACKING 包裝
LED G45 Globe Bulb 球形膽 - 5W					
LLG45E27 / E14-5W-DL	6500K	420lm	E27 / E14	>80	48pcs/ctn.
LLG45E27 / E14-5W-WW	2700K	400lm			
LED G95 Globe Bulb 球形膽 - 12W					
LLG95E27 / B22-12W-DL	6500K	1050lm	E27 / B22	>80	24pcs/ctn.
LLG95E27-12W-WW	2700K	1000lm	E27		
LED G120 Globe Bulb 球形膽 - 18W					
LLG120E27 / B22-18W-DL	6500K	1600lm	E27 / B22	>80	12pcs/ctn.
LLG120E27-18W-WW	2700K	1500lm	E27		

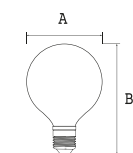

WATT 瓦數		5W	12W	18W
SIZE 呎吋	A	45mm	95mm	120mm
	B	82mm	127mm	160mm
SRP 建議零售價 (HK\$)		\$ 23.90	\$ 47.90	\$ 74.90

LED Globe Bulb LED 球形膽 vs Incandescent 烏絲膽

5W → 35W
12W → 90W
18W → 120W

IEC
62471

IEC
62560

CE

20,000
Hours

270°
SUPER
WIDE ANGLE

220V-240V~
50/60HZ

UP TO
85%
ENERGY
SAVINGS

NO
UV/IR

Waste
Recycling
Symbol

SAFE
EASY TO USE

RoHS
Compliant

Waste
Recycling
Symbol

LED Globe Bulb
LED 球形膽



- Elegant appearance with brightness flashing 外型優雅，閃爍明亮
- Up to 90% energy savings when compare to incandescent 比烏絲燈膽節能高達90%
- Mercury free 不含水銀
- Less heat emission 熱能釋出量低
- 20,000 Hours of average lifetime 平均壽命可達20,000 小時

LED
Lite

LED Candle Bulb
LED 蠟燭燈



LED Candle Bulb LED 蠟燭燈



MODEL 型號	CT 色溫	LUMENS 流明	LAMP BASE 燈腳	CRI 顯色度	PACKING 包裝
LED Frosted Cover Candle Bulb 磨砂面蠟燭燈 - 6W					
LCF35E14-6W-DL	6500K	400lm	E14	>80	48pcs/ctn.
LCF35E14-6W-WW	2700K	370lm			
LED Clear Cover Candle Bulb 清面蠟燭燈 - 6W					
LCC35E14-6W-DL	6500K	400lm	E14	>80	48pcs/ctn.
LCC35E14-6W-WW	2700K	370lm			

MODEL 型號	CT 色溫	WATT瓦數	LUMENS 流明	LAMP BASE 燈腳	CRI 顯色度	PACKING 包裝
Clear Cover Dimmable Candle Bulb 清面調光蠟燭燈						
LCC35E14D-6W-DL	6500K	6W	380lm	E14	>80	48pcs/ctn.
LCC35E14D-6W-WW	2700K		350lm			

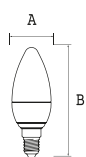

Frosted / Clear Cover Candle Bulb 磨砂/清面蠟燭燈		6W
SIZE 呎吋	A	35mm
	B	99mm
SRP 建議零售價 (HK\$)		\$ 41.90

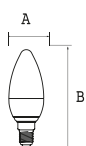

Clear Cover Dimmable Candle Bulb 清面調光蠟燭燈		6W
SIZE 呎吋	A	36mm
	B	105mm
SRP 建議零售價 (HK\$)		\$ 89.90

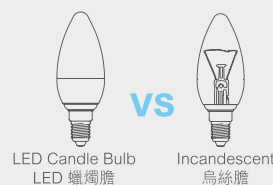

6W → 40W

IEC
62471

IEC
62560



20,000
Hours

270°
SUPER
WIDE ANGLE

220V-240V~
50/60Hz

UP TO
85%
ENERGY
SAVINGS

NO
UV/IR

SAFE
EASY TO USE

RoHS
Compliant



LED Candle Bulb
LED 蠟燭燈



- Ultra-slim design for different lampshade 纖巧時尚設計，易於配合不同燈飾及燈具
- 360° wide beam angle 360° 廣闊發光角度
- 50% energy savings when compared to CFL pinlights 比傳統慳電膽節能50%
- Mercury free 不含水銀
- Less heat emission 熱能釋出量低
- 20,000 Hours of average lifetime 平均壽命可達20,000 小時



LED
Lite

LED Pinlight
LED 插拔管燈

* Registered Patent 註冊專利:
Appearance Patent 外觀專利設計 ZL201430334974.4
China Utility Model Patent 中國實用新型專利 ZL2014205203.9

LED Pinlight LED 插拔管燈



MODEL 型號	CT 色溫	LUMENS 流明	LAMP BASE 燈腳	CRI 顯色度	PACKING 包裝
LED Pinlight 插拔管燈 - 7W Applicable to 6-inch downlight casing 適用於6吋筒燈外殼					
LPLE27 / E14 -7W-DL	6500K	600lm	E27 / E14	>80	48pcs/ctn.
LPLG24D / G24Q*-7W-DL			G24D /G24Q*		
LPLG24D-7W-CW	4000K	580lm	G24D		
LPLE27 / E14 -7W-WW	2700K	550lm	E27 / E14		
LPLG24D-7W-WW	2700K	550lm	G24D		
LED Pinlight 插拔管燈 - 9W Applicable to 6-inch downlight casing 適用於6吋筒燈外殼					
LPLE27 / E14 -9W-DL	6500K	840lm	E27 / E14	>80	48pcs/ctn.
LPLG24D-9W-DL	6500K	840lm	E27 / G24D		
LPLE27 / G24D-9W-CW	4000K	830lm			
LPLE27 / G24D-9W-WW	2700K	810lm			
LED Pinlight 插拔管燈 - 12W Applicable to 8-inch downlight casing 適用於8吋筒燈外殼					
LPLG24D-12W-DL	6500K	1100lm	G24D	>80	48pcs/ctn.
LPLG24D-12W-CW	4000K	1050lm			
LPLG24D-12W-WW	2700K	1000lm			

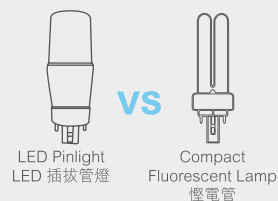

7W → 11W
9W → 15W
12W → 18W

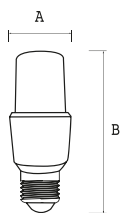

WATT 瓦數		7W	9W	12W
SIZE 呎吋	A	38mm	38mm	38mm
	B	104mm	108mm	151mm
SRP 建議零售價 (HK\$)		\$ 42.90	\$ 79.90	\$ 99.90

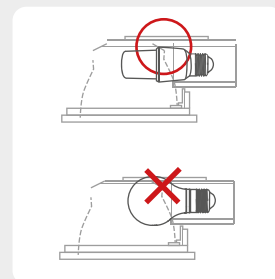

* Indent Order 需預訂

LED Pinlight
LED 插拔管燈



- Wide range of illumination 照明範圍廣闊
- 85% energy savings 節能高達85%
- Easy installation and dismantle 簡易安裝及拆除
- Mercury free 不含水銀
- Less heat emission 熱能釋出量低
- 20,000 Hours of average lifetime 平均壽命可達20,000 小時

LED
Lite

LED Flat Lamp
LED 簡約頂燈



LED Flat Lamp

LED 簡約頂燈



MODEL 型號	CT 色溫	LUMENS 流明	LAMP BASE 燈腳	CRI 顯色度	PACKING 包裝
LED Flat Lamp 簡約頂燈 - 15W					
LFE27 / B22-15W-DL	6500K	1350lm	E27 / B22	>80	10pcs/ctn.
LFE27-15W-WW	2700K	1300lm	E27		
LED Flat Lamp 簡約頂燈 - 22W					
LFE27 / B22-22W-DL	6500K	1900lm	E27 / B22	>80	10pcs/ctn.
LFE27-22W-WW	2700K	1800lm	E27		
LED Flat Lamp 簡約頂燈 - 30W					
LFE27 / B22-30W-DL	6500K	2500lm	E27 / B22	>80	6pcs/ctn.
LFE27-30W-WW	2700K	2400lm	E27		

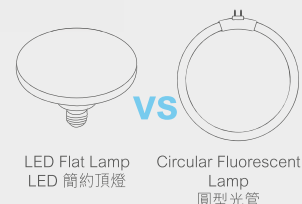

15W → 25W
22W → 32W
30W → 42W

IEC 62471	IEC 62560	CE
20,000 Hours	120° WIDE ANGLE	220V-240V-50/60Hz
UP TO 85% ENERGY SAVINGS	NO UV/IR	Recycling symbol
SAFE EASY TO USE	RoHS Compliant	Waste disposal symbol

WATT 瓦數		15W	22W	30W
SIZE 呎吋	A	143mm	201mm	310mm
	B	112mm	140mm	130mm
SRP 建議零售價 (HK\$)		\$ 64.90	\$ 122.90	\$ 169.90

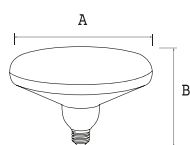

LED Flat Lamp
LED 簡約頂燈



- 3 colours or brightness in 1 bulb 一個燈膽擁有3種色溫或光度
- Switch on and off for colour or brightness changing 開關燈制便能轉換色溫或調較光度
- The bulb is applicable to traditional switch, no dimmer is required
可配合傳統開關燈制，不用配備調光器

LED
Lite

LED TRIO 3-colors Bulb
LED TRIO 三色燈



LED TRIO 3-Colors Bulb

LED TRIO 三色燈



MODEL 型號	CT 色溫	WATT 瓦數	BEAM ANGLE 發光角度	LUMENS 流明	LAMP BASE 燈腳	CRI 顯色度	PACKING 包裝
LED TRIO A Bulb 三色A形球膽 (No Dimmer Required 無需調光器)							
LLA60E27-9W-TRIO	2700K	9W	270°	700lm	E27	>80	48pcs/ctn.
	6000K			800lm			
	4000K			750lm			
LED TRIDIM A Bulb 三段調光A形球膽 (No Dimmer Required 無需調光器)							
LLA60E27-9WW-TD		9W	270°	700lm 450lm 150lm	E27	>80	48pcs/ctn.
LED TRIO Flat Lamp 三色簡約頂燈 (No Dimmer Required 無需調光器)							
LFE27/B22-22W-TRIO	2700K	22W	120°	1700lm	E27	>80	10pcs/ctn.
	6000K			1900lm			
	4000K			1800lm			
LFE27/B22-30W-TRIO	2700K	30W	120°	2400lm	E27	>80	6pcs/ctn.
	6000K			2700lm			
	4000K			2600lm			

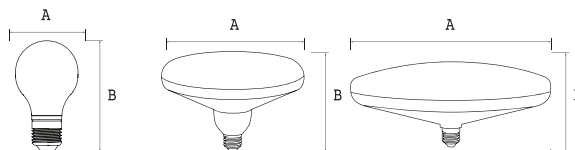

PRODUCT 產品		TRIDIM 9W	TRIO 9W	TRIO FLAT LAMP 22W	TRIO FLAT LAMP 30W
SIZE 呎吋	A	60mm	60mm	201mm	310mm
	B	110mm	110mm	140mm	130mm
SRP 建議零售價 (HK\$)		\$59.90	\$ 79.90	\$ 169.90	\$ 199.90

LED TRIO A Bulb
三色A形球膽



Video Demo 示範短片



LED TRIDIM A Bulb
三段調光A形球膽



Video Demo 示範短片



LED TRIO Flat Lamp
三色簡約頂燈



Video Demo 示範短片



IEC
62471

IEC
62560



20,000
Hours



UP TO
85%
ENERGY
SAVINGS



LED TRIO 3-Colors Bulb
LED TRIO 三色燈



- High Colour rendering index and moderate luminosity 顯色度高，光度適中
- Applicable to most of the Buddhist Kiosks, electrical lotus light and candle holder 適用於大部份神樓、電子蓮花燈及燭檯
- Lower power consumption and less heat emission, suitable for prolonged use 低能源使用及熱能釋出，適合長時間使用

LED
Lite

LED Red Bulb
LED 紅燈膽



LED Red Bulb

LED 紅燈膽



MODEL 型號	CT 色溫	WATT 瓦數	LAMP BASE 燈腳	PACKING 包裝
LED Red Round Bulb 紅球膽	IEC 62560	IEC 62471		
LRR-1.5W	RED	1.5W	B22	60pcs/ctn.
LED Red Candle Bulb 紅蠟燭膽	IEC 62560	IEC 62778		
LMR-0.5WE12	RED	0.5W	E12	24pcs/ctn.

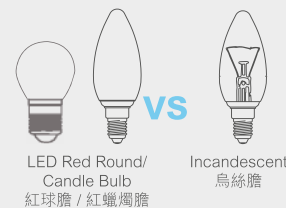

0.5W → 5W
1.5W → 10W

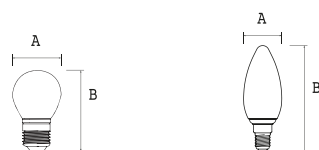

PRODUCT 產品		Round Bulb 球膽	Candle Bulb 蠟燭膽 - 0.5W
SIZE 呎吋	A	40mm	20mm
	B	70mm	69mm
SRP 建議零售價 (HK\$)		\$ 21.90	\$25.90



LED Red Bulb
LED 紅燈膽



- Aluminum and plastic material enhance the heat dissipation 半鋁塑物料，提昇散熱能力
- With microwave sensor type for selection 備有微波感應款式可供選擇
- Mercury free 不含水銀
- Less heat emission 熱能釋出量低

LED
Lite

LED T8 Tube
LED T8 光管



LED T8 Tube

LED T8 光管



Double Ended Input Tube 雙端輸入光管

MODEL 型號	FT 呎	CT 色溫	BEAM ANGLE 發光角度	LUMENS 流明	LAMP BASE 燈腳	CRI 顯色度	PACKING 包裝
LED T8 Aluminum and Plastic Tube 鋁塑光管							
LT8A2C-10W-DL	2	6500K	180°	900lm	G13	>80	30pcs/ctn.
LT8A2C-10W-WW		3000K		800lm			
LT8A2C-20W-DL	4	6500K		1800lm			
LT8A2C-20W-WW		3000K		1700lm			
LT8A2C-24W-DL	5	6500K		2160lm			
LT8A2C-24W-WW		3000K		2040lm			

Feature 特性:

- Metal and plastic lamp body. 金屬及塑料燈體。
- Without fragile material. 無易碎物質。
- Durable and resistant to collision. 不易損壞，堅固耐用，可抵抗一定的碰撞衝擊。
- New generation of solid-state lighting, no ultraviolet, infrared and radiation. 采用新一代固體光源我，不含紫外綫、紅外綫和輻射。
- Environmental friendly, non-toxic materials, no harmful gases and mercury, 100% recyclable. 環保無害，由無毒的材料製作，不含有害他體，無汞，100%可回收利用。
- With EMC certified models for selection. 備有通過EMC 測試的型號可貨選擇。

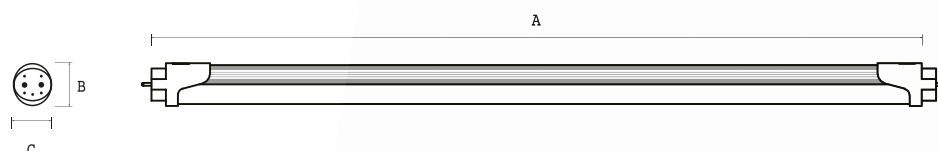

LENGTH 長度		2 FT 呎	4 FT 呎	5 FT 呎
SIZE 呎吋	A	588mm	1198mm	1498mm
	B	32mm	32mm	32mm
	C	28mm	28mm	28mm
SRP 建議零售價 (HK\$)		\$ 99.90	\$ 119.90	\$ 149.90

LED T8 Aluminum and Plastic Tube
LED T8 鋁塑光管

VS

Fluorescent Tube
光管

10W → 17W

20W → 35W

24W → 42W

IEC
62471

IEC
62776

CE

30,000
Hours

>0.5
Power Factor

180°
SUPER
WIDE ANGLE

220V-240V~
50/60Hz

UP TO
50%
ENERGY
SAVINGS

NO
UV/IR

SAFE
EASY TO USE

RoHS
Compliant

3-YEAR
WARRANTY

LED T8 Tube
LED T8 光管

LED T8 Tube LED 光管



Double Ended Input Tube 雙端輸入光管

MODEL 型號	FT 呎	CT 色溫	BEAM ANGLE 發光角度	LUMENS 流明	LAMP BASE 燈腳	CRI 顯色度	PACKING 包裝
LED T8 Micro Sensor Aluminum and Plastic Tube 微波感應鋁塑光管							
LT8MS-2C-10W-DL	2	6500K	180°	830lm	G13	>80	30pcs/ctn.
LT8MS-2C-10W-WW		3000K		790lm			
LT8MS-2C-20W-DL	4	6500K		1700lm			
LT8MS-2C-20W-WW		3000K		1600lm			
LT8MS-2C-24W-DL	5	6500K		2040lm			
LT8MS-2C-24W-WW		3000K		1950lm			

Feature 特性:

- The operating principle of micro sensor is to detect the movement of human body or object. When a human body or object is moving within the sensing range, the tube will light up automatically. 微波感應以探測人體或物體移動為目標，只要在微波感應範圍內有人體或物體移動，光管會自動亮起。
- The microwave signal from micro sensor tube can penetrate non-metallic objects, such as curtains, thin walls and so on. 微波感應光管所發出的微波信號可穿透非金屬物，如窗簾，薄牆等。
- With anti-radio frequency interference ability, the sensitivity will not be affected by temperature, humidity, light, air, dust and so on. 具有抗射頻干擾能力，不會受溫度、濕度、光線、氣流、塵埃等影響其感應力。
- The sensing range of microwave sensor can be up to 8 meters and automatically light off after leaving 30 seconds. 微波感應敏銳，感應範圍可遠達8米，離開後30秒自動關閉。

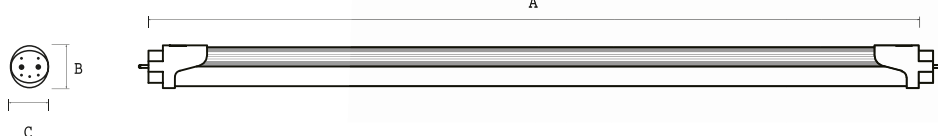

LENGTH 長度		2 FT 呎	4 FT 呎	5 FT 呎
SIZE 呎吋	A	588mm	1198mm	1498mm
	B	32mm	32mm	32mm
	C	28mm	28mm	28mm
SRP 建議零售價 (HK\$)		\$ 129.90	\$ 149.90	\$ 169.90



LED T8 Micro Sensor Tube
LED T8 微波感應光管

VS



Fluorescent Tube
光管

10W → 16W

20W → 34W

24W → 40W

IEC
62471

IEC
62776

CE

30,000
Hours

>0.5
Power Factor

180°
SUPER
WIDE ANGLE

220V-240V~
50/60Hz

UP TO
50%
ENERGY
SAVINGS

NO
UV/IR

RoHS
Compliant

**3-YEAR
WARRANTY**

LED T8 Tube
LED T8 光管

LED T8 Tube

LED T8 光管



Double Ended Input Tube 雙端輸入光管

MODEL 型號	FT 呎	CT 色溫	BEAM ANGLE 發光角度	LUMENS 流明	LAMP BASE 燈腳	CRI 顯色度	PACKING 包裝
LED T8 Plastic Tube 全塑光管							
LT8-10W-DL	2	6500K	180°	1000lm	G13	>80	20pcs/ctn.
LT8-10W-CW		4000K		950lm			
LT8-10W-WW		3000K		900lm			
LT8-20W-DL	4	6500K	180°	2000lm	G13	>80	20pcs/ctn.
LT8-20W-CW		4000K		1900lm			
LT8-20W-WW		3000K		1800lm			

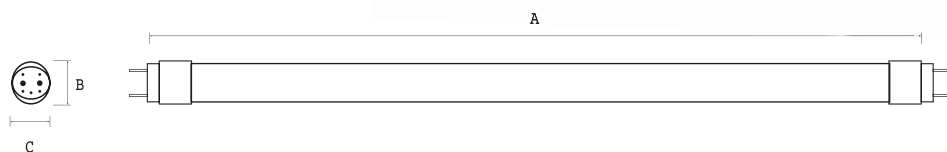

LENGTH 長度		2 FT 呎	4 FT 呎
SIZE 呎吋	A	600mm	1200mm
	B	32mm	32mm
	C	28mm	28mm
SRP 建議零售價 (HK\$)		\$ 99.90	\$ 119.90

LED T8 Double Ended Input Plastic Tube
LED T8 雙端輸入全塑光管

VS
Fluorescent Tube 光管

10W → 18W
20W → 36W

- IEC 62471
- IEC 60598
- CE
- 20,000 Hours
- >0.9 Power Factor
- 180° SUPER WIDE ANGLE
- 220V-240V~50/60Hz
- UP TO 60% ENERGY SAVINGS
- NO UV/IR
- RoHS compliant
- SAFE EASY TO USE

LED T8 Tube
LED T8 光管

LED T8 Tube

LED T8 光管



Single Ended Input Tube 單端輸入光管

MODEL 型號	FT 呎	CT 色溫	BEAM ANGLE 發光角度	LUMENS 流明	LAMP BASE 燈腳	CRI 顯色度	PACKING 包裝
LED T8 Plastic Tube 全塑光管							
LT8S-10W-DL	2	6500K	180°	1000lm	G13	>80	20pcs/ctn.
LT8S-10W-CW		4000K		950lm			
LT8S-10W-WW		3000K		900lm			
LT8S-20W-DL	4	6500K		2000lm			
LT8S-20W-CW		4000K		1900lm			
LT8S-20W-WW		3000K		1800lm			

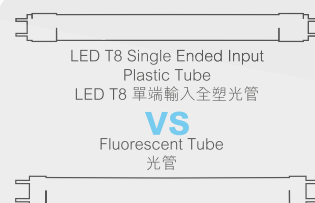

10W → 18W
20W → 36W



- IEC 60598
- IEC 62471
- CE
- 20,000 Hours
- >0.9 Power Factor
- 180° SUPER WIDE ANGLE
- 220V-240V~50/60Hz
- UP TO 60% ENERGY SAVINGS
- NO UV/IR
- SAFE EASY TO USE
- RoHS Compliant
- Recycling symbol

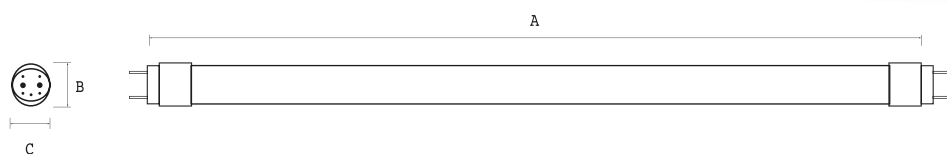

LENGTH 長度		2 FT 呎	4 FT 呎
SIZE 呎吋	A	600mm	1200mm
	B	32mm	32mm
	C	28mm	28mm
SRP 建議零售價 (HK\$)		\$ 89.90	\$ 109.90

LED T8 Tube

LED T8 光管



Single Ended Input Tube 單端輸入光管

MODEL 型號	FT 呎	CT 色溫	BEAM ANGLE 發光角度	LUMENS 流明	LAMP BASE 燈腳	CRI 顯色度	PACKING 包裝
LED T8 Glass Tube 玻璃光管							
LT8G-24W-DL	5	6500K	270°	2200lm	G13	>80	20pcs/ctn.
LT8G-24W-CW		4000K		1800lm			



24W → 42W

IEC 60598	IEC 62471	CE
15,000 Hours	>0.5 Power Factor	270° SUPER WIDE ANGLE
220V-240V~50/60Hz	UP TO 70% ENERGY SAVINGS	NO UV/IR
RoHS Compliant	SAFE EASY TO USE	RoHS Compliant

LED T8 Tube
LED T8 光管

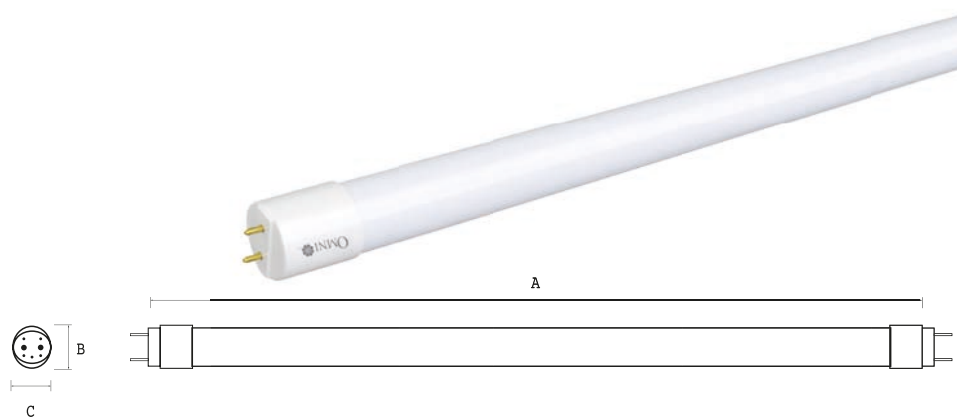

LENGTH 長度		5 FT 呎
SIZE 呎吋	A	1512mm
	B	32mm
	C	28mm
SRP 建議零售價 (HK\$)		\$ 99.90

Recommended Accessory 推介配件

Fuse 保險絲:
LT8-FUSE



SRP 建議零售價 (HK\$)

\$ 4.90



- 90% energy savings when compared to halogen bulb 比石英膽節能高達90%
- UV, IR and Mercury free 不含紫外線、紅外線及水銀
- Less heat emission 熱能釋出量低
- 20,000 Hours of average lifetime 平均壽命可達20,000 小時時
- 24°, 38° and 60° beam angle available 備有24°, 38° 及 60°發光角度可供選擇

LED
Lite

LED MR11 Spotlight
LED MR11 射燈



LED MR11 Spotlight

LED MR11 射燈



MODEL 型號	CT 色溫	BEAM ANGLE 發光角度	LUMENS 流明	LAMP BASE 燈腳	CRI 顯色 度	PACKING 包裝
-------------	----------	-----------------------	--------------	--------------------	----------------	---------------

NEW LED MR11 Spotlight 射燈 - 4W

LSMR11GU4-4W	2700K-6500K	24°/38°/60°*	200lm	GU4	80/90	50pcs/ctn.
--------------	-------------	--------------	-------	-----	-------	------------

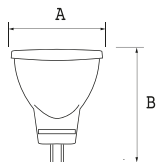

WATT 瓦數		4W
SIZE 呎吋	A	34mm
	B	42mm
SRP 建議零售價 (HK\$)		\$ 99.90

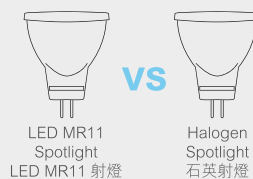

4W → 25W

IEC
62031

IEC
62493

IEC
62778

IEC
62838

CE

20,000
Hours

220V-240V~
50/60Hz

UP TO
90%
ENERGY
SAVINGS

NO
UV/IR



SAFE
EASY TO USE

RoHS
Compliant



* Indent Order 需預訂

Recommended Fixture 推介燈具:

MODEL 型號	INPUT 輸入	OUTPUT 輸出	Tc 表面溫度	Ta 環境溫度	PACKING 包裝
-------------	-------------	--------------	------------	------------	---------------

LED Driver 驅動器

LDD-030	95-240V~50/60Hz	12V=1A 1-10W	75°C	40°C	100pcs/ctn.
---------	-----------------	--------------	------	------	-------------



IEC
61347



- 90% energy savings when compared to halogen bulb 比石英膽節能高達90%
- UV, IR and Mercury free 不含紫外線、紅外線及水銀
- Mercury free 不含水銀
- Less heat emission 熱能釋出量低
- 20,000 Hours of average lifetime 平均壽命可達20,000 小時
- 10°, 24°, 38°, 60° and 100° beam angle available
備有10°、24°、38°、60°及100°發光角度供選擇

LED
Lite

LED MR16 Spotlight
LED MR16 射燈



LED MR16 Spotlight

LED MR16 射燈



MODEL 型號	CT 色溫	BEAM ANGLE 發光角度	LUMENS 流明	LAMP BASE 燈腳	CRI 顯色度	PACKING 包裝
LED MR16 Spotlight 射燈 - 5W						
LFGU5.3-5W-6K-38	6500K	38°	420lm	GU5.3	>80	48pcs/ctn.
LFGU10/GU5.3-5W-4K-10°/24°	4000K	10°/24°	400lm	GU10 / GU5.3		
LFGU10/GU5.3-5W-3K-10°/24°	3000K		380lm			
LFGU10/GU5.3-5W-2K-10°/24°	2700K		380lm			
LFGU10/GU5.3-5W-4K-38°/100°	4000K	38°/100°	400lm	GU10 / GU5.3		
LFGU10/GU5.3-5W-3K-38°/100°	3000K		380lm			
LFGU10/GU5.3-5W-2K-38°/100°	2700K		380lm			
LED MR16 Spotlight 射燈 - 8W						
LFGU10/GU5.3-8W-4K	4000K	38°	630lm	GU10 / GU5.3	>80	48pcs/ctn.
LFGU10/GU5.3-8W-3K	3000K		600lm			
LFGU10/GU5.3-8W-2K	2700K		600lm			
LED MR16 Spotlight 射燈 - 12W						
LFGU10-12W-4K	4000K	60°	980lm	GU10	>80	48pcs/ctn.
LFGU10-12W-3K	3000K		950lm			
LFGU10-12W-2K	2700K		950lm			

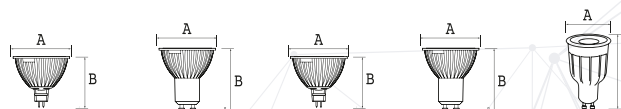

PRODUCT 產品		5W GU5.3	5W GU10	8W GU5.3	8W GU10	12W GU10
SIZE 呎吋	A	47mm	47mm	50mm	50mm	50mm
	B	45mm	55mm	49mm	56mm	80mm
SRP 建議零售價 (HK\$)		\$ 42.90		\$ 52.90		\$ 109.90

LED MR16 Spotlight LED MR16 射燈

vs

Halogen Spotlight 石英射燈

5W → 35W

8W → 50W

12W → 80W

IEC 62471

IEC 62031

CE

20,000 Hours

220V-240V~50/60Hz

UP TO 90% ENERGY SAVINGS

NO UV/IR

SAFE EASY TO USE

RoHS Compliant

Waste Recycle Symbol

只適用於 GU5.3

DC 12V

* Indent Order 需預訂

LED MR16 Spotlight
LED MR16 射燈

LED MR16 Dimmable Spotlight

LED MR16 調光射燈



LED MR16 Dimmable Spotlight
LED MR16 調光射燈

MODEL 型號	CT 色溫	WATT 瓦數	BEAM ANGLE 發光角度	LUMENS 流明	LAMP HOLDER 燈腳	CRI 顯色度	PACKING 包裝
LED MR16 Dimmable Spotlight 調光射燈							
LFMR16GU5.3/10D-5W-DL	4000K	5W	38°	400lm	GU5.3/ GU10	>80	48pcs/ctn.
LFMR16GU5.3/10D-5W-WW	2700K/ 3000K			380lm			
LFMR16GU5.3/ GU10D-8W-DL	4000K	8W	38°	630lm	GU5.3*/ GU10		
LFMR16GU5.3/ GU10D-8W-WW	2700K/ 3000K			600lm			
LFMR16GU10D-12W-DL	4000K	12W	60°	980lm	GU10*		
LFMR16GU10D-12W-WW	2700K			950lm			

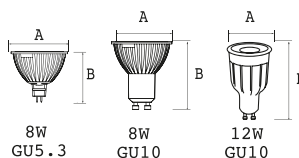

MR16 Dimmable Spotlight 調光射燈		5W	8W	12W
SIZE 呎吋	A	47mm	50mm	50mm
	B	55mm	56mm	90mm
SRP 建議零售價 (HK\$)		\$69.90	\$ 79.90	\$ 122.90

VS



LED MR16
Dimmable
Spotlight
LED MR16
調光射燈



Dimmable
Halogen
Spotlight
調光石英射燈

5W → 35W
8W → 50W
12W → 70W

IEC
62471

IEC
62560

CE

20,000
Hours

220V-240V~
50/60Hz

UP TO
90%
ENERGY
SAVINGS

NO
UV/IR

SAFE
EASY TO USE

RoHS
Compliant

X

只適用於
GU5.3

DC
12V

* Indent Order 需預訂

LED Adjustable Downlight LED 可調角度筒燈



MODEL 型號	CT 色溫	BEAM ANGLE 發光角度	RADIATION ANGLE 照射角度	LUMENS 流明	CRI 顯色度	PACKING 包裝
NEW LED Adjustable Downlight 可調角度筒燈 - 8W [^]						
LLRC-38RM-8WW	3000K	38°	30°+30° = 60°	580lm	>80	48pcs/ctn.

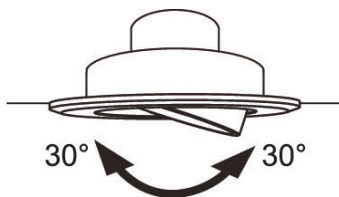

LED Adjustable Downlight可調角度筒燈 Radiation Angle 照射角度

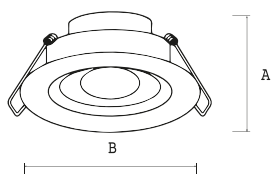

ø70mm
Cutout Size

WATT 瓦數		8W
SIZE呎吋	A	55mm
	B	90mm
SRP 建議零售價 (HK\$)		\$99.90

IEC 62031	IEC 62471	IEC 62560
CE	15,000 Hours	220V-240V~ 50/60Hz
UP TO 85% ENERGY SAVINGS	60° WIDE ANGLE	NO UV/IR
SAFE EASY TO USE	RoHS Compliant	Recycling symbol

[^] Dimmable version can be ordered
可訂制調光版本

LED Adjustable Downlight
LED 可調角度筒燈



- Slim design and best fit for narrow space 纖薄設計，適用於狹窄空間
- Suitable for surface-mounted luminaries and recessed fitting 適用於吸頂燈或表面裝置式燈具
- 20,000 Hours of average lifetime 平均壽命可達20,000小時



LED GX53 Cabinet Lamp LED GX53 櫥櫃燈



LED GX53 Cabinet Lamp

LED GX53 櫥櫃燈



MODEL 型號	CT 色溫	LUMENS 流明	CRI 顯色度	PACKING 包裝
LED GX53 Cabinet Lamp GX53櫥櫃燈 - 7W^{**}				
LGX53-7W-DL	6500K	560lm	>80	50pcs/ctn.
LGX53-7W-CW	4000K	540lm		
LGX53-7W-WW	2700K	530lm		

IEC
62471

IEC
62560



20,000
Hours



^{*} Dimmable version can be ordered
可預訂調光版本
^{*} Indent Order 需預訂

LED GX53 Cabinet Lamp
LED GX53 櫥櫃燈

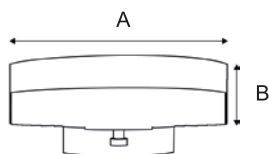

WATT 瓦數		7W
Size 呎吋	A	75mm
	B	28mm
SRP 建議零售價 (HK\$)		\$128.00



- Slim fit design 纖巧設計
- LED driver included plus installation accessories
配備LED 驅動器及安裝組件
- 20,000 Hours of average lifetime 平均壽命可達20,000小時
- Mercury free 不含水銀



LED Panel Light LED 平板燈



LED Panel Light LED 平板燈

MODEL 型號	CT 色溫	WATT 瓦數	LUMENS 流明	CRI 顯色度	PACKING 包裝
LED Square Panel Light 正方形平板燈					
LP330-18W-DL/CW/WW	6500K / 4000K* / 2700K*	18W	1440lm	>80	5pcs/ctn.
LP660-40W-DL/CW/WW		40W	3200lm		6pcs/ctn.
LED Rectangular Panel Light 長方形平板燈					
LP312-40W-DL/CW/WW	6500K / 4000K* / 2700K*	40W	3200lm	>80	8pcs/ctn.
LP612-60W-DL/CW/WW		60W	4800lm		3pcs/ctn.

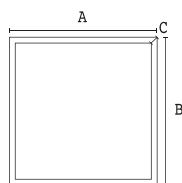

Square Panel Light 正方形平板燈		18W	40W
SIZE 呎吋	A	295mm	595mm
	B	295mm	595mm
	C	10.5mm	10.5mm
SRP 建議零售價 (HK\$)		\$399.00	\$520.00

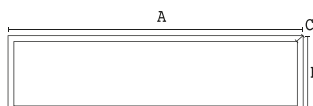

Rectangular Panel Light 長方形平板燈		40W	60W
SIZE 呎吋	A	1195mm	1195mm
	B	295mm	595mm
	C	10.5mm	10.5mm
SRP 建議零售價 (HK\$)		\$670.00	\$860.00

Recommended Fixture 推介燈具:

Surface Mounted Frame* 吸頂框*



Model No 型號: SMF-330 / SMF-660 / SMF-312 / SMF-612

Suspended Mounting Kit 懸掛安裝套裝



Model No 型號: SMK-1845

IEC 60598

IEC 62471

CE

20,000 Hours

120° SUPER WIDE ANGLE

220V-240V~50/60Hz

NO UV/IR

SAFE EASY TO USE

RoHS compliant

X

Dimmable version can be ordered
可預訂調光版本
* Indent Order 需預訂

LED Panel Light
LED 平板燈



- Higher light output 極高光源輸出
- Wider beam angle up to 360° 發光角度廣闊，可達360度
- Mercury free 不含水銀
- Less heat emission 熱能釋出量低
- Over 20,000 Hours average lifetime 平均壽命可達20,000小時以上



LED High Power Bulb LED 高效能燈膽



LED High Power Bulb

LED 高效能燈膽



MODEL 型號	CT 色溫	BEAM ANGLE 發光角度	LUMENS 流明	LAMP BASE 燈腳	CRI 顯色度	PACKING 包裝
LED High Power Pillar Lamp 高效能柱燈 - 20W			IEC 60061			
LM65E27-20W-DL	6500K	360°	2100lm	E27	>80	24pcs/ctn.
LM65E27-20W-WW	2700K		2000lm			
LED High Power Pillar Lamp 高效能柱燈 - 45W						
LMB120E27-45W-DL	6500K	360°	3600lm	E27	>80	20pcs/ctn.
LMB120E27-45W-WW	3000K		3200lm			
LED High Power Pillar Lamp 高效能柱燈 - 55W						
LMB120E27-55W-DL	6500K	360°	4600lm	E27	>80	20pcs/ctn.
LMB120E27-55W-WW	3000K		3700lm			

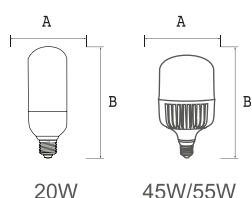

WATT 瓦數		20W	45W	55W
SIZE 呎吋	A	64.5mm	120mm	120mm
	B	184mm	200mm	200mm
SRP 建議零售價 (HK\$)		\$ 99.00	\$ 115.00	\$ 139.00

LED High Power Pillar Lamp
高效能柱燈

20W → 42W

LED High Power Pillar Lamp
高效能柱燈

45W → 70W
55W → 80W

IEC 62031

IEC 62778

IEC 62560

CE

20,000 Hours

220V-240V~50/60Hz

UP TO 85% ENERGY SAVINGS

NO UV/IR

SAFE EASY TO USE

RoHS Compliant

* Indent Order 需預訂

LED High Power Bulb
LED 高效能燈膽



- Ultra Slim design with external driver, suitable for lower ceiling.
超薄燈體設計，搭配上外置式驅動器，特別適用於矮樓底
- Matt white finishing that is readily adaptable to any ceiling design.
啞白色外蓋易於融入各式各樣天花設計
- 20,000hours average lifetime. 平均壽命可達20,000小時



LED Ultra Slim Downlight LED 超薄筒燈



LED Ultra Slim Downlight LED 超薄筒燈



MODEL 型號	CT 色溫	LUMENS 流明	INCHES 吋	CRI 顯色度	PACKING 包裝
NEW LED Ultra Slim Downlight 超薄筒燈 - 9W *					
LRCS-9WDL	6000K	600lm	5"	>80	20pcs/ctn.
LRCS-9WCW	4000K	550lm			
LRCS-9WW	3000K	500lm			
NEW LED Ultra Slim Downlight 超薄筒燈 - 12W					
LRCS-12WDL	6000K	900lm	6"	>80	20pcs/ctn.
LRCS-12WCW	4000K	850lm			
LRCS-12WW	3000K	800lm			
NEW LED Ultra Slim Downlight 超薄筒燈 - 16W					
LRCS-16WDL	6000K	1200lm	7"	>80	10pcs/ctn.
LRCS-16WCW	4000K	1150lm			
LRCS-16WW	3000K	1100lm			
NEW LED Ultra Slim Downlight 超薄筒燈 - 18W *					
LRCS-18WDL	6000K	1600lm	8"	>80	10pcs/ctn.
LRCS-18WCW	4000K	1550lm			
LRCS-18WW	3000K	1500lm			

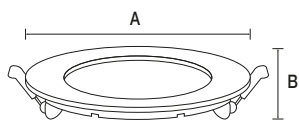

WATT 瓦數		9W	12W	16W	18W
SIZE 呎吋	A	140mm	170mm	199mm	224mm
	B	25mm	25mm	25mm	25mm
CUTOUT SIZE 開孔呎吋	Ø	125mm	150mm	175mm	200mm
	SRP 建議零售價 (HK\$)	\$99.00	\$129.00	\$159.00	\$189.00

IEC 60598	IEC 61347 Driver	IEC 62031
IEC 62471	CE	20,000 Hours
100° WIDE ANGLE	220V~240V~ 50/60Hz	UP TO 85% ENERGY SAVINGS
NO UV/IR	>0.5 Power Factor	
SAFE EASY TO USE	RoHS Compliant	

* Indent Order 需預訂

Remarks 備註:

- External Driver is included
產品已配備外置驅動器
- Dimmable Version is avail-
able through indent order
可預訂調光版本

LED Ultra Slim Downlight
LED 超薄筒燈



- Aluminum heatsink enhance heat dissipation 採用鋁料散熱器，提昇散熱能力
- Maintenance free fixture. Lamp and driver in one assembly 燈與驅動器一體化，免卻保養燈具
- Warranty period up to 5-YEAR 保養期最高可長達5年

LED

LED Integrated Recessed Downlight LED 一體化嵌入式筒燈



LED Integrated Recessed Downlight LED 一體化嵌入式筒燈



MODEL 型號	CT 色溫	INCH 吋	WATT 瓦數	BEAM ANGLE 發光角度	LUMENS 流明	CUT OUT SIZE 開孔尺寸	CRI 顯色 度	PACKING 包裝
-------------	----------	-----------	------------	-----------------------	--------------	-------------------------	----------------	---------------

NEW LED Deluxe Recessed Downlight 豪華嵌入式筒燈*

LCDM-4-12W	2700K / 3000K / 4000K / 5000K	4"	12W	40° / 60°	1050lm	100mm	>80	1pcs/ctn.
LCDM-6-20W		6"	20W		1850lm	150mm		
LCDM-6-30W		6"	30W		2450lm	150mm		
LCDM-8-40W		8"	40W		3450lm	200mm		

NEW LED Supreme Recessed Downlight 至尊嵌入式筒燈*

LHID-6-60W	3000K / 4000K / 5000K / 5800K	6"	60W	60°	5800lm	100mm	>80	1pcs/ctn.
LHID-8-60W		8"	60W		5800lm	200mm		
LHID-10-100W		10"	100W		9500lm	250mm		
LHID-12-100W		12"	100W		9500lm	300mm		

LED Integrated Recessed Downlight
LED 一體化嵌入式筒燈



LED Deluxe Recessed Downlight

- 豪華嵌入式筒燈
- Nichia LED COB Clips
- Lifud Driver
- 90V - 265V

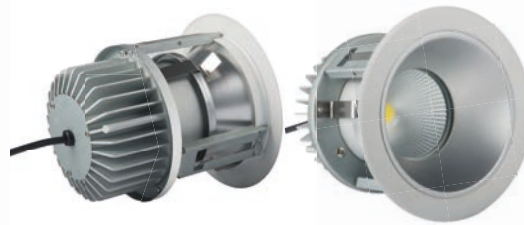

LED Supreme Recessed Downlight

- 至尊嵌入式筒燈
- Citizen COB Clips
- Meanwell Driver
- 90V - 265V

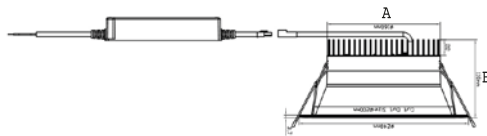

Deluxe Recessed Downlight 豪華嵌入式筒燈		12W	20W	30W	40W
SIZE 呎吋	A	140mm	190mm	190mm	240mm
	B	95mm	110mm	110mm	110mm
SRP 建議零售價 (HK\$)		\$ 690.00	\$ 790.00	\$ 890.00	\$ 990.00

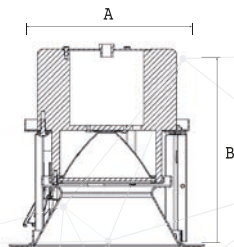

Supreme Recessed Downlight 至尊嵌入式筒燈		6" 60W	8" 60W	10" 100W	12" 100W
SIZE 呎吋	A	169mm	220mm	270mm	340mm
	B	163mm	165mm	197mm	197mm
SRP 建議零售價 (HK\$)		\$ 1690.00	\$ 1790.00	\$ 2999.90	\$ 3499.90



IEC
60598

40,000
Hours



UP TO
85%
ENERGY
SAVINGS



5-YEAR
WARRANTY



NO
UV/IR



SAFE
EASY TO USE



RoHS
Compliant



* Indent Order 需預訂



- Integrated tracklight with easy installation with adjustable angle
一體化路軌燈方便安裝，並可自由調教照射方向
- Suitable for both retail chain stores, boutiques, restaurants and etc.
適用於連鎖零售店，精品店，餐館等等
- Special round shape tracklight design, best fit for wide range illumination
獨特圓形路軌燈設計，適用於需要廣角照明的環境



LED COB Track Light LED COB 路軌燈



LED COB Track Light

LED COB 路軌燈



MODEL 型號	WATT 瓦數	CT 色溫	LUMENS 流明	ANGLE 角度	CRI 顯色度	COLOUR 顏色	PACKING 包裝
----------	---------	-------	-----------	----------	---------	-----------	------------

NEW LED COB Track Spotlight (3-year warranty) 高顯色度路軌射燈* (3年保用)- LCTH

LCTH-7W	7W	2700K-6000K	770lm	40°	≥90	Black/White 黑/白	20pcs/ctn.
LCTH-12W	12W		1200lm				
LCTH-20W	20W		2300lm				
LCTH-30W	30W		3300lm				

NEW LED COB Track Spotlight 路軌射燈* - LCTL

LCTL-20W-CW	20W	4000K	1800lm	45°	≥80	Black/White 黑/白	20pcs/ctn.
LCTL-20W-WW		3000K					
LCTL-24W-CW	24W	4000K	2160lm				
LCTL-24W-WW		3000K					
LCTL-30W-CW	30W	4000K	2700lm				
LCTL-30W-WW		3000K					

* Indent Order 需預訂

LED COB Track Light
LED COB 路軌射燈

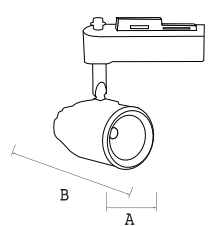

PRODUCT 產品		LCTH			
WATT 瓦數		7W	12W	20W	30W
Size 呎吋	A	115mm	115mm	138mm	138mm
	B	174mm	174mm	199mm	199mm
SRP 建議零售價 (HK\$)		\$ 245.00	\$ 288.00	\$ 450.00	\$ 510.00

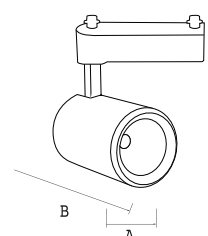

PRODUCT 產品		LCTL		
WATT 瓦數		20W	24W	30W
Size 呎吋	A	86mm	86mm	95mm
	B	125mm	125mm	140mm
SRP 建議零售價 (HK\$)		\$ 170.00	\$ 199.00	\$ 238.00

MODEL 型號	WATT 瓦數	CT 色溫	LUMENS 流明	CRI 顯色度	PACKING 包裝
----------	---------	-------	-----------	---------	------------

NEW LED Flat Track Light 路軌圓頂燈*

LCTC-18W	18W	2700K-6500K	1290lm-1440lm	≥80	10pcs/ctn.
LCTC-24W	24W		1800lm-1920lm		

WATT 瓦數		18W	24W
Size 呎吋	A	225mm	235mm
	B	40mm	40mm
SRP 建議零售價 (HK\$)		\$ 170.00	\$ 199.00

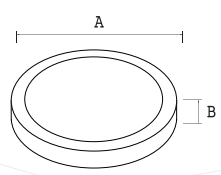

* Indent Order 需預訂



- Integrated high bay lamp for easy installation and maintenance
一體化設計高樓底照明，方便安裝及保養
- A variety of accessories are available, which best fit for different environment
備有多種配件可供選購，適合不同環境需要
- Warranty period up to 5-YEAR
保養期最高可長達5年

LED

LED High Bay Lamp LED 高樓底燈



LED High Bay Lamp LED 高樓底燈



MODEL 型號	CT 色溫	WATT 瓦數	BEAM ANGLE 發光角度	LUMENS 流明	CRI 顯色度	PACKING 包裝
-------------	----------	------------	-----------------------	--------------	------------	---------------

NEW LED Multiplicity High Bay Lamp 多樣式高樓底燈**

LSHN-100W-DL	5000K	100W	60°# / 70°# / 90°# / 120°#	13000lm	>80	1pcs/ctn.
LSHN-100W-CW	4000K			12000lm		
LSHN-150W-DL	5000K	150W		19500lm		
LSHN-150W-CW	4000K			18000lm		
LSHN-200W-DL	5000K	200W		26000lm		
LSHN-200W-CW	4000K			24000lm		

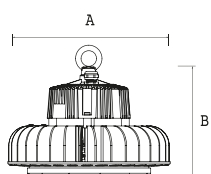

Multiplicity High Bay Lamp 多樣式高樓底燈		100W	150W	200W
SIZE 呎吋	A	252mm	252mm	280mm
	B	180mm	180mm	228mm
SRP 建議零售價 (HK\$)		\$ 1680.00	\$ 2080.00	\$ 2580.00

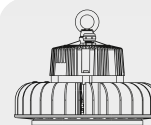

LED
Multiplicity High
Bay Lamp
LED 多樣式高樓底燈

High Pressure
Mercury
Lamp
高壓水銀燈

100W → 230W
150W → 380W
200W → 500W



IEC
60598

IEC
62471

40,000
Hours

IP65

UL

SAA

TüV

5-YEAR
WARRANTY



UP TO
50%
ENERGY
SAVINGS



SAFE
EASY TO USE



Recommended Fixture 推介燈具:

Multiplicity High Bay Plastic Diffuser* 多樣式高樓底燈膠散光罩*



Model No 型號: LSHN-PC
Size 呎吋: 276mm(H) X 413mm(W)
Beam Angle 發光角度: 70°

Multiplicity High Bay Aluminum Diffuser* 多樣式高樓底燈鋁散光罩*



Model No 型號: LSHN-AL-60 / LSHN-AL-90 / LSHN -AL-120
Size 呎吋: 60°-130mm(H) x 343mm(W) /
90°-130mm(H) x 353mm(W) /
120°-119mm(H) x 500mm(W)
Beam Angle 發光角度: 60°/90°/120°

Multiplicity High Bay Sensor* 多樣式高樓底燈感應器*



Model No 型號: LSHN-S

Multiplicity High Bay Mounted Holder* 多樣式高樓底燈天花支架*



Model No 型號: LSHN-C

Multiplicity High Bay Adjustable Angle Holder* 多樣式高樓底燈調角度支架*



Model No 型號: LSHN-A

* Indent Order 需預訂
Apply together with diffuser
需配合散光罩
^ Dimmable version can be ordered
可訂制調光版本



- Mercury, UV and IR free 不含水銀，紫外線及紅外線
- Enclosed material gives it an IP65 waterproof rating which is good enough for indoor use
外層物料達IP65 防水級別，適合室內使用
- Lower lighting color difference and SDCM value 光源色彩差異少及色容差值低



LED Strip Light LED 燈帶

LED Strip Light DC 12V

LED 燈帶 DC 12V



MODEL 型號	CHIP晶片	CT色溫	WATT 瓦數	LUMENS 流明	BOARD WIDTH 燈帶闊度	LED QUNTITY 燈珠數量	CRI 顯色度	PACKING 包裝
NEW LED Strip light DC 12V 燈帶 DC 12V*								
LSDC-9.6W	SMD2835	4000K/6500K	9.6W	650lm/meter	8mm	60pcs/meter	>80	5meters/roll
LSDC-12W	SMD2835	4000K/6500K	12W	950lm/meter	10mm	120pcs/meter		
LSDC-12W-50	SMD5050	4000K/6500K	12W	900lm/meter	10mm	60pcs/meter		
NEW LED RGB Strip light DC 12V RGB燈帶 DC 12V*								
LSDC-10W-RGB	SMD5050	RGB	10W	NA	10mm	60pcs/meter	>80	5meters/roll

WATT 瓦數	9.6W	12W	12W(SMD5050)	RGB 10W
SRP 建議零售價 (HK\$)	\$ 279.50	\$ 399.50	\$ 499.50	\$ 499.50

CE

UL

IP65

**DC
12V**

NO
UV/IR



* Indent Order 需預訂

LED Strip Light DC 12V
LED 燈帶 DC 12V

Strip Light Connector Kit DC 12V

燈帶連接器套裝

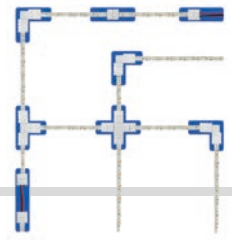

Recommended Fixture 推介燈具:

MODEL 型號	WATT 瓦數	WIDTH 闊度
Strip Light Connector Kit DC 12V 燈帶連接器套裝		
LSPC-DC-8MM	9.6W	8mm
LSPC-DC-10MM	12W	10mm

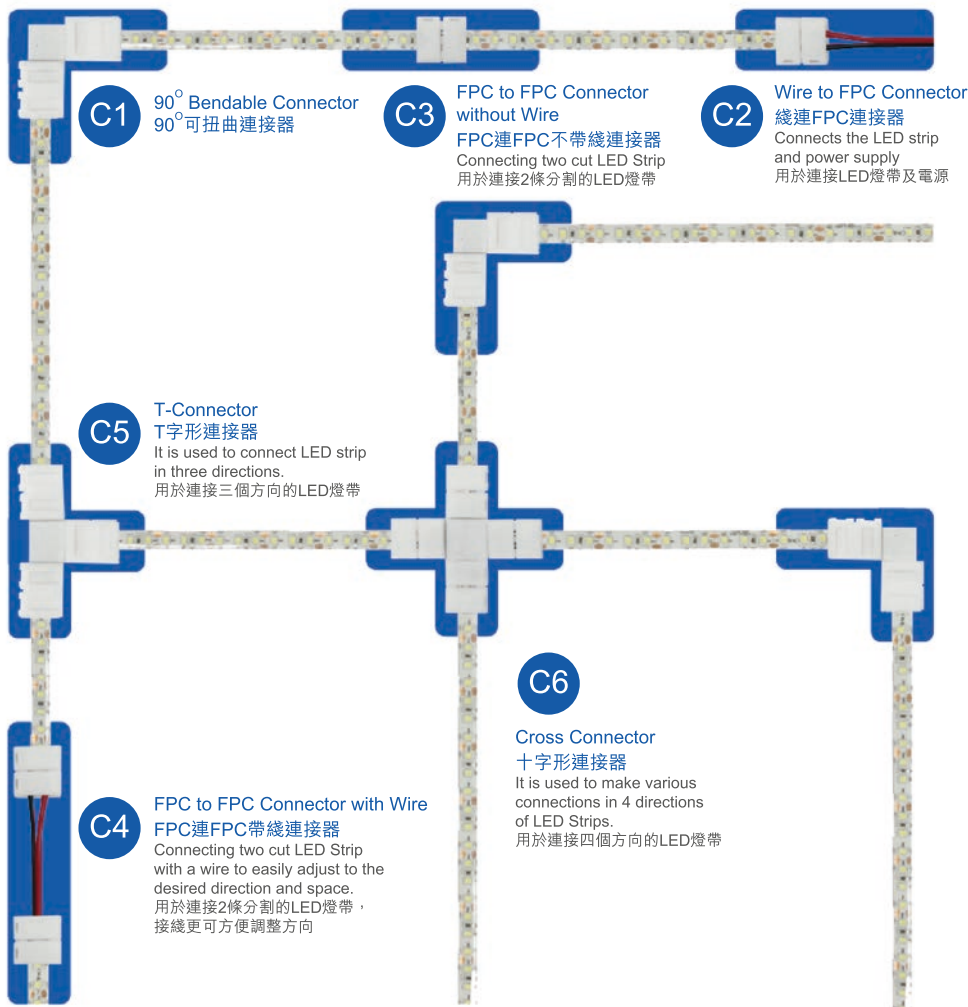

Kit Includes 套裝包括:

- C1 x 1
- C2 x 1
- C3 x 2
- C4 x 1
- C5 x 1
- C6 x 1

SRP 建議零售價 (HK\$)	\$49.90
------------------	---------

LED Strip Light Driver

LED 燈帶驅動器



12V Strip Light Accessories 12V 燈帶配件:

MODEL 型號	OUTPUT 輸出	EFFICIENCY 效能	WEIGHT 重量	PACKING 包裝
-------------	--------------	------------------	--------------	---------------

LED Driver 12V LED 驅動器 12V - 60W

LDD-060	5A	82%	0.25Kg	10pcs/ctn.
---------	----	-----	--------	------------

Max. LED Strip Length LED 燈帶長度限制: 8W x 5 meters

LED Driver 12V LED 驅動器 12V - 72W

LDD-072	6A	84%	0.31Kg	10pcs/ctn.
---------	----	-----	--------	------------

Max. LED Strip Length LED 燈帶長度限制: 12W x 12 meters



LDD-060/LDD-072

SRP 建議零售價 (HK\$)	\$169.90	\$229.90
------------------	----------	----------

MODEL 型號	OUTPUT 輸出	EFFICIENCY 效能	WEIGHT 重量	PACKING 包裝
-------------	--------------	------------------	--------------	---------------

LED Driver 12V LED 驅動器 12V - 80W

LDD-080	6.67A	82%	0.55Kg	10pcs/ctn.
---------	-------	-----	--------	------------

Max. LED Strip Length LED 燈帶長度限制: 8W x (2 x 5 meters)

LED Driver 12V LED 驅動器 12V - 150W

LDD-150	12.50A	83%	0.85Kg	10pcs/ctn.
---------	--------	-----	--------	------------

Max. LED Strip Length LED 燈帶長度限制: 12W x (2 x 5 meters)

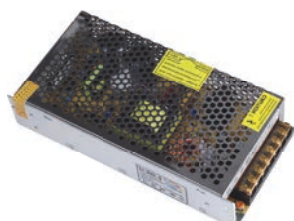

LDD-080/LDD-150

SRP 建議零售價 (HK\$)	\$149.90	\$199.90
------------------	----------	----------

LED Strip Light Driver
LED 燈帶驅動器



- Up to 85% energy savings when compare to incandescent par lamp 比烏絲射燈節能高達85%
- Weatherproof IP65 rating 達IP65 防水級別
- Lightweight design 輕量設計
- Stays cool even after long period of use 長時間使用仍能保持低溫
- Higher light intensity up to 15 meters 長達15 米光照強度
- Mercury free 不含水銀

LED
Lite

LED Par Lamp
LED 射燈



LED Par Lamp

LED 射燈



MODEL 型號	CT 色溫	BEAM ANGLE 發光角度	LUMENS 流明	LAMP BASE 燈腳	CRI 顯色度	PACKING 包裝
LED Par 20 Lamp 射燈20 - 6W						
LPR20E27-6W/D	6500K	30°	400lm	E27	>80	48pcs/ctn.
LPR20E27-6W/W	2700K		380lm			
LED Par 30 Lamp 射燈30 - 10W IP65						
LPR30E27-10W/D	6500K	30°	750lm	E27	>80	24pcs/ctn.
LPR30E27-10W/W	2700K		700lm			
LED Par 38 Lamp 射燈38 - 15W IP65						
LPR38E27-15W/D	6500K	30°	1100lm	E27	>80	12 pcs/ctn.
LPR38E27-15W/W	2700K		1000lm			

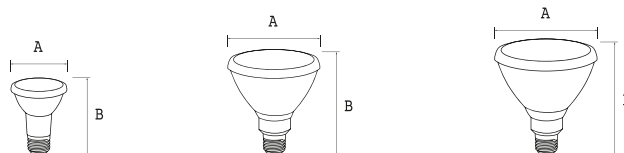

WATT 瓦數		6W	10W	15W
SIZE 呎吋	A	63mm	97mm	120mm
	B	91mm	100mm	135mm
SRP 建議零售價 (HK\$)		\$ 99.90	\$ 169.90	\$ 209.90

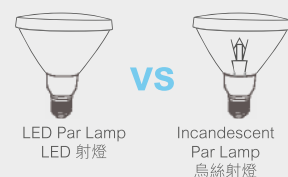

LED Par Lamp LED 射燈

Incandescent Par Lamp 烏絲射燈

6W → 50W

10W → 80W

15W → 120W



LED Par Lamp
LED 射燈



- With IP54 weatherproof level and E27 lamp base for easier replacement and maintenance
IP54防水級別，E27燈頭方便更換保養
- Applicable to garden, park, playground, roadway, etc.
適用於庭園、公園、遊樂場及路面等
- 360° super wide beam angle can cover wider area
360° 超闊發光角度，覆蓋照射範圍更廣



LED High Power Garden Bulb LED 高效能庭園燈膽

LED High Power Garden Bulb

LED 高效能庭園燈膽



MODEL 型號	WATT 瓦數	LAMP BASE 燈腳	CT 色溫	LUMENS 流明	PACKING 包裝
-------------	------------	--------------------	----------	--------------	---------------

NEW LED Weatherproof High Power Pillar Bulb 防水高效能柱燈*

LMC-30W	30W	E27	2300K-6000K	3900lm	12pcs/ctn.
LMC-40W	40W	E27/E40		5200lm	
LMC-60W	60W	E40		7800lm	
LMC-70W	70W			9100lm	
LMC-90W	90W			11700lm	

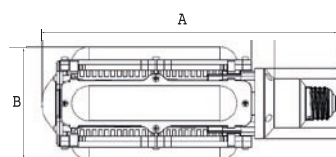

WATT 瓦數		30W	40W	60W	70W	90W
Size 呎吋	A	231mm	231mm	231mm	258mm	247mm
	B	88mm	88mm	88mm	88mm	107mm
SRP 建議零售價 (HK\$)		\$760.00	\$900.00	\$1290.00	\$1790.00	\$2490.00

CE

PSE

40,000
Hours

IP54

>0.95
Power Factor

3-YEAR
WARRANTY

360°
BEAM ANGLE

100V-240V~
50/60Hz



RoHS
Compliant

* Indent Order 需預訂

* Dimmable Version is available
by order
可預訂調光版本

LED High Power Garden Bulb
LED 高效能庭園燈膽



- Non corrosive plastic casing can resist external corrosion
外殼用上非腐蝕性塑料，能抵擋外來侵蝕
- Weatherproof IP65 rating 達IP65 防水級別
- Can be ceiling or wall mounted 可安裝於天花或牆上
- Opaque diffuser for soft light effect without glare 不透明的擴散器使燈光更柔和
- Mercury free 不含水銀

LED
Lite

LED Weatherproof Light
LED 防水燈



LED Weatherproof Light

LED 防水燈



MODEL 型號	WATT 瓦數	CT 色溫	LUMENS 流明	CRI 顯色度	PACKING 包裝
LED Circular Weatherproof Light 圓形防水燈			20,000 Hours		
LWCL-20WDL	20W	6500K	1800lm	>80	10pcs/ctn.
LWCL-20WW		2700K	1600lm		
LED Rectangular Weatherproof Light 長方形防水燈			15,000 Hours		
LWSL-20WDL	20W	6500K	1600lm	>80	10pcs/ctn.
LWSL-20WW		2700K	1500lm		
LWSL-15WDL	15W	6500K	1200lm	>80	10pcs/ctn.
LWSL-15WW		2700K	1100lm		

MODEL 型號	CT 色溫	LUMENS 流明	CRI 顯色度	PACKING 包裝
LED Microwave Sensor Weatherproof Light 微波感應防水燈 - 20W				
LWSL-MS20WDL	6500K	1600lm	>80	10pcs/ctn.
LWSL-MS20WW	2700K	1500lm		

Feature 特性:

- The microwave sensor will detect the movement of human body or object. When a human body or object is moving within the sensing range, the light will light up automatically.
微波感應會探測人體或物體移動，當人體或物體於微波感應範圍內移動，防水燈會自動亮起。
- The sensing range of microwave sensor can be up to 5 meters with sensing angle 180° x 260° and automatically light off after leaving 30 seconds.
- 微波感應敏銳，感應範圍可遠達8米，感應角度可達180° x 260°，並於離開後30秒自動關閉。

IEC 60598

IEC 62031

IEC 61347

CE

IP65

180° SUPER WIDE ANGLE

220V-240V~ 50/60Hz

UP TO 85% ENERGY SAVINGS

NO UV/IR

SAFE EASY TO USE

RoHS Compliant

LED Weatherproof Light
LED 防水燈

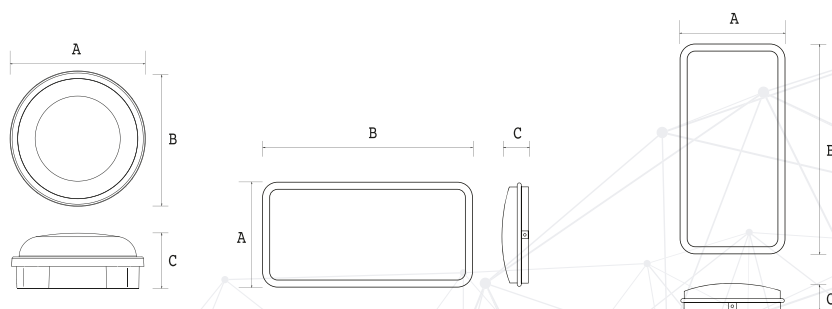

PRODUCT 產品		Circular 圓形 - 20W	Rectangular 長方形 - 15W	Rectangular 長方形 - 20W	LED Microwave Sensor Weatherproof Light 微波感應防水燈
Size 呎吋	A	221mm	115mm	146mm	146mm
	B	221mm	234mm	296mm	296mm
	C	80mm	70mm	76mm	76mm
SRP 建議零售價 (HK\$)		\$249.90	\$199.90	\$239.90	\$299.90

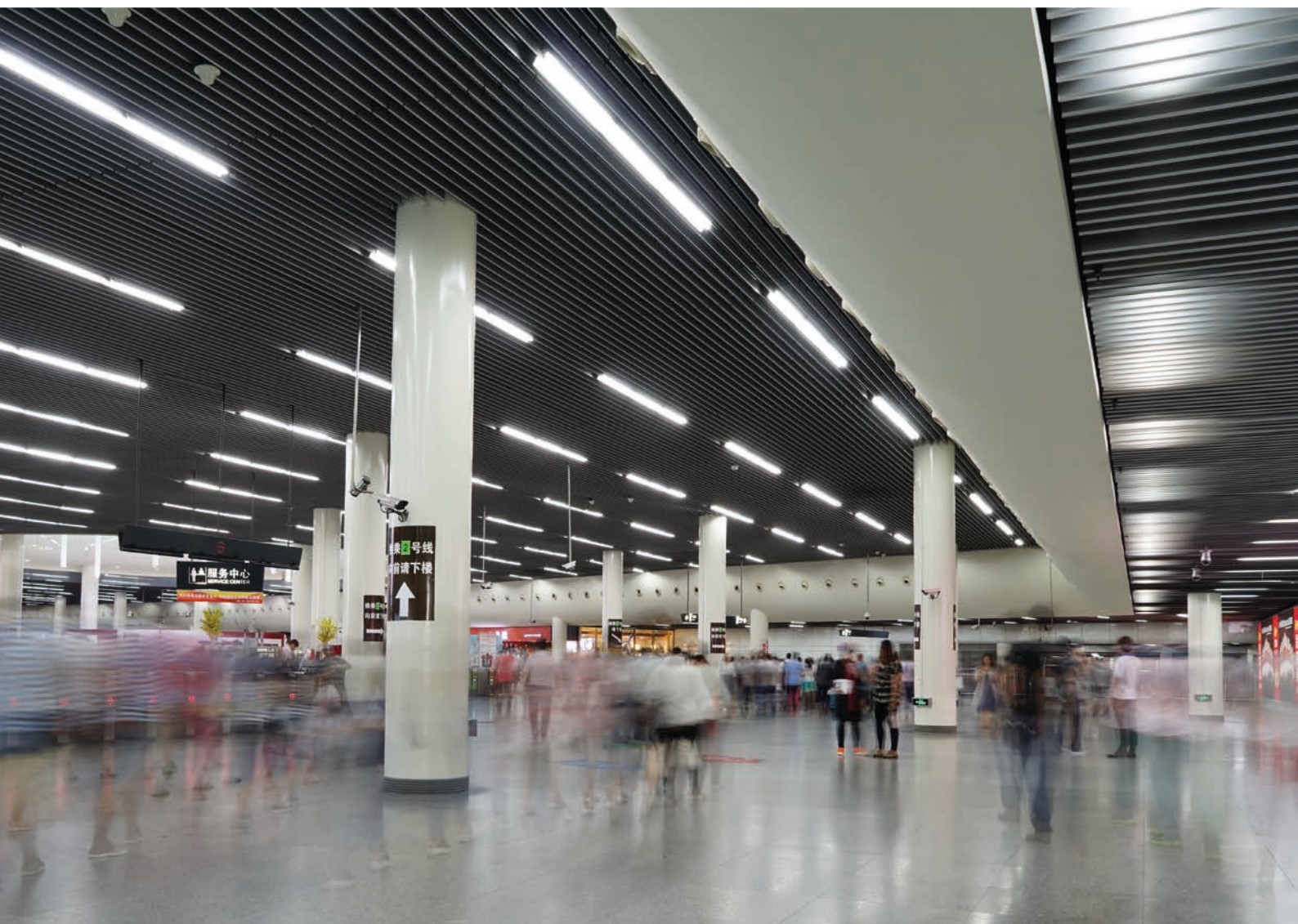

- Integrated slim and neat design with smooth finishing 一體化纖巧利落設計，呈現出光滑外觀
- Uniform light output for better area coverage 光源輸出一致，照射範圍覆蓋更佳
- With IP65 for both indoor and outdoor applications 達IP65防水防塵級別，室內或室外應用佳宜
- Surface-mounted or suspended application 掛牆或懸吊式安裝皆可



LED Weatherproof Fixture (Ultra Slim Linear Light) LED 一體化纖巧三防支架



LED Weatherproof Fixture (Ultra Slim Linear Light) LED 一體化纖巧三防支架



MODEL 型號	CT 色溫	LUMENS 流明	CRI 顯色度	PACKING 包裝
NEW LED Weatherproof Fixture (Ultra Slim Linear Light) 一體化纖巧三防支架 - 18W				
LLW-18W-DL	6500K	1600lm	72	20pcs/ctn.
LLW-18W-CW	4000K	1550lm		
NEW LED Weatherproof Fixture (Ultra Slim Linear Light) 一體化纖巧三防支架 - 36W				
LLW-36W-DL	6500K	3200lm	72	20pcs/ctn.
LLW-36W-CW	4000K	3000lm		
NEW LED Weatherproof Fixture (Ultra Slim Linear Light) 一體化纖巧三防支架 - 45W				
LLW-45W-DL	6500K	4000lm	72	20pcs/ctn.
LLW-45W-CW	4000K	3800lm		

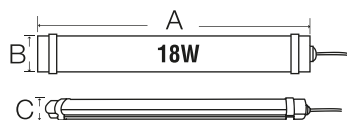

WATT 瓦數		18W	36W	45W
Size 呎吋	A	600mm	1200mm	1500mm
	B	60mm	60mm	60mm
	C	35mm	35mm	35mm
SRP 建議零售價 (HK\$)		\$148.00	\$198.00	\$260.00

CE

IEC 60598

EMC

SAA

25,000 Hours

IP65

>0.9
Power Factor

120°
WIDE ANGLE

180V-265V~
50/60Hz

NO
UV/IR

SAFE
ASY TO USE

RoHS
Compliant

X

LED Weatherproof Fixture (Ultra Slim Linear Light)
LED 一體化纖巧三防支架



- Pure copper heat pipe and massive cooling fins for effective heat dissipation
純銅片及巨形降溫片，有助散熱
- Non-corrosive aluminum reflector and casing
外殼用上防腐蝕鋁材及反射物料



LED Weatherproof Flood Light LED 傳統防水泛光燈



LED Weatherproof Flood Light

LED 傳統防水泛光燈



MODEL 型號	CT 色溫	LUMENS 流明	CRI 顯色度	WEIGHT 重量	PACKING 包裝
LED Weatherproof Flood Light 傳統防水泛光燈 - 20W				3-YEAR WARRANTY	
LFLD-20W	2700K - 6500K	2400lm	>80	0.83Kg	20pcs/ctn.
LED Weatherproof Flood Light 傳統防水泛光燈 - 30W				3-YEAR WARRANTY	
LFLD-30W	2700K - 6500K	3600lm	>80	1.03Kg	20pcs/ctn.
LED Weatherproof Flood Light 傳統防水泛光燈 - 50W				5-YEAR WARRANTY	
LFLD-50W	2700K - 6500K	5500lm	>80	2.8Kg	4pcs/ctn.
LED Weatherproof Flood Light 傳統防水泛光燈 - 70W				5-YEAR WARRANTY	
LFLD-70W	2700K - 6500K	7700lm	>80	3Kg	1pcs/ctn.
LED Weatherproof Flood Light 傳統防水泛光燈 - 100W				5-YEAR WARRANTY	
LFLD-100W	2700K - 6500K	11000lm	>80	5Kg	1pcs/ctn.
LED Weatherproof Flood Light 傳統防水泛光燈 - 150W				5-YEAR WARRANTY	
LFLD-150W	2700K - 6500K	16500lm	>80	7.28Kg	1pcs/ctn.
LED Weatherproof Flood Light 傳統防水泛光燈 - 200W				5-YEAR WARRANTY	
LFLD-200W	2700K - 6500K	22000lm	>80	7.5Kg	1pcs/ctn.

CE

IEC 60598

IEC 62031

IEC 61347

IP65

>0.9
Power Factor

120°
WIDE ANGLE

30,000-50,000
Hours

220V-240V~
50/60Hz

NO UV/IR

SAFE
EASY TO USE

RoHS
Compliant

X

* Indent Order 需預訂

Remark :

20-30W
OSRAM 3030 LED Chips

50-200W
Lumileds LED
Meanwell ELG Driver

LED Weatherproof Flood Light
LED 傳統防水泛光燈

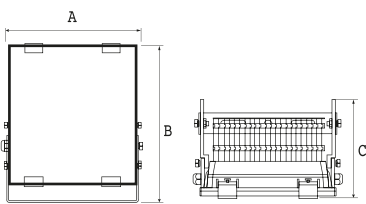

WATT 瓦數		20W	30W	50W	70W	100W	150W	200W
Size 呎吋	A	150mm	166mm	227mm	227mm	278mm	280mm	326mm
	B	171mm	176mm	283mm	283mm	319mm	390mm	330mm
	C	55mm	71mm	122mm	122mm	182mm	196mm	462mm
SRP 建議零售價 (HK\$)		\$599.90	\$699.90	\$1490.90	\$1790.90	\$2490.90	\$3490.90	\$4499.90



- Multi adjustable angle with fasten screw 多角度調教並配備定位螺絲
- ADC12 Aluminum casing for effective heat dissipation 外殼用上ADC12 鋁料，有效散熱
- Ultra slim and lightweight design from 25mm to 40mm thick 纖巧輕盈設計，厚度僅由25mm 至40mm
- Tempered glass 鋼化玻璃
- Weatherproof IP65 rating 達IP65 防水級別
- With microwave and light sensor model 備有微波及光控感應款式



LED Weatherproof Slim Flood Light LED 纖巧防水泛光燈



LED Weatherproof Slim Flood Light

LED 纖巧防水泛光燈



MODEL 型號	CT 色溫	WATT 瓦數	LUMENS 流明	CRI 顯色度	PACKING 包裝
LED Weatherproof Slim Flood Light 纖巧防水泛光燈					
LLFL-10WDL	6500K	10W	900lm	>70	40pcs/ctn.
LLFL-10WW*	2700K		850lm		
LLFL-20WDL	6500K	20W	1800lm	>70	20pcs/ctn.
LLFL-20WW*	2700K		1700lm		
LLFL-30WDL	6500K	30W	2700lm	>70	10pcs/ctn.
LLFL-30WW*	2700K		2550lm		
LLFL-40WDL	6500K	40W	3600lm	>70	10pcs/ctn.
LLFL-40WW*	2700K		3400lm		
NEW LLFL-80WDL*	6500K	80W	7200lm	>70	6pcs/ctn.
NEW LLFL-80WW*	2700K		6800lm		
NEW LLFL-100WDL	6500K	100W	9000lm	>70	5pcs/ctn.
NEW LLFL-100WW	2700K		8500lm		

WATT 瓦數		10W	20W	30W	40W
Size 呎吋	A	130mm	185mm	230mm	270mm
	B	95mm	135mm	168mm	190mm
	C	41mm	44.5mm	47mm	47mm
SRP 建議零售價 (HK\$)		\$ 199.90	\$ 249.90	\$ 319.90	\$ 399.90

WATT 瓦數		80W	100W
Size 呎吋	A	290mm	330mm
	B	200mm	233mm
	C	53mm	57mm
SRP 建議零售價 (HK\$)		\$ 699.90	\$ 999.90

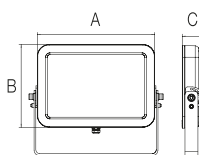

IEC 60598

IEC 62471

CE

IP65

25,000 Hours

110° WIDE ANGLE

100-305V 50/60Hz

UP TO 85% ENERGY SAVINGS

NO UVIR

SAFE EASY TO USE

RoHS Compliant

INNOVATIONS 創新
Respirator Design 呼吸器設計

Balance the different pressure between the atmosphere and the shell, it is water proof also defog and avoiding drop condensation and reducing the inside salt corrosion and extending the product lifespan.

平衡環境和外殼之間不同的壓力，並具有防水防霧功能，可避免水滴凝結、減少內鹽腐蝕和延長產品壽命。

LED Weatherproof Slim Flood Light
LED 纖巧防水泛光燈

*Indent Order 需預訂

LED Duo Sensor Weatherproof Slim Flood Light

LED 雙重感應纖巧防水泛光燈



LED Duo Sensor Weatherproof Slim Flood Light
LED 雙重感應纖巧防水泛光燈

MODEL 型號	CT 色溫	WATT 瓦數	LUMENS 流明	CRI 顯色度	PACKING 包裝
LED Duo Sensor Weatherproof Slim Flood Light 雙重感應纖巧防水泛光燈					
LLFL-30WMS-DL	6500K	30W	2700lm	>70	10pcs/ctn.
LLFL-30WMS-WW	2700K		2550lm		
LLFL-40WMS-DL	6500K	40W	3600lm	>70	10pcs/ctn.
LLFL-40WMS-WW	2700K		3400lm		

- A combination of micro sensor and lighting sensor.
備有微波感應及光控功能於一體
- Adjustable micro sensing distance (3-8 meters), auto light off timer (2 seconds -5 minutes) and environment lighting sensitivity level (2-500 lux).
可自由調校微波感應距離 (3-8米)、延長關燈時間 (2秒-5分鐘) 及環境光度感應值 (2-500lux)
- Farther and wider (180°) sensing distance when compare with infrared sensor.
比紅外線產品的感應距離更遠及闊 (180°)
- No extra space for lens installation is needed.
不需額外開孔加裝透鏡
- Not influence by temperature, dust, etc. and more durable.
不受環境溫度、灰塵等影響，更耐用

WATT 瓦數		30W	40W
Size 呎吋	A	230mm	270mm
	B	168mm	190mm
	C	47mm	47mm
	D	45mm	45mm
	E	70mm	70mm
SRP 建議零售價 (HK\$)		\$529.00	\$599.00

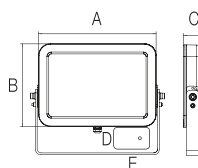

IEC 60598

IEC 62471

CE

IP65

25,000 Hours

110° WIDE ANGLE

100-305V 50/60Hz

UP TO 85% ENERGY SAVINGS

NO UV/IR

SAFE EASY TO USE

RoHS Compliant

X

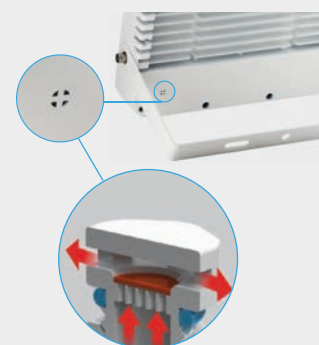

INNOVATIONS 創新 Respirator Design 呼吸器設計

Balance the different pressure between the atmosphere and the shell, it is water proof also defog and avoiding drop condensation and reducing the inside salt corrosion and extending the product lifespan.

平衡環境和外殼之間不同的壓力，並具有防水防霧功能，可避免水滴凝結、減少內鹽腐蝕和延長產品壽命。

LED Weatherproof Multi Function Flood Light

LED 多功能防水泛光燈



MODEL 型號	CT 色温	LUMENS 流明	CRI 顯色度	PACKING 包裝
LED Weatherproof Multi Function Flood Light 多功能防水泛光燈 - 50W*				
LFML-50W-DL	6500K	5000lm	>80	40pcs/ctn.
LFML-50W-WW	2700K	4000lm		
LED Weatherproof Multi Function Flood Light 多功能防水泛光燈 - 80W*				
LFML-80W-DL	6500K	8000lm	>80	20pcs/ctn.
LFML-80W-WW	2700K	7000lm		
LED Weatherproof Multi Function Flood Light 多功能防水泛光燈 - 120W*				
LFML-120W-DL	6500K	12000lm	>80	10pcs/ctn.
LFML-120W-WW	2700K	11000lm		

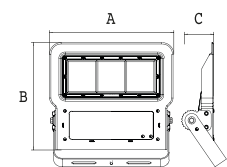

WATT 瓦數		50W	80W	120W
Size 呎吋	A	240mm	300mm	360mm
	B	208mm	260mm	312mm
	C	48mm	91mm	94mm
SRP 建議零售價 (HK\$)		\$399.90	\$499.90	\$599.90

Recommended Fixture 推介燈具:

Spike-mounted Luminaire 插泥燈具



Model No 型號: LFML-SM

CE

IP65

25,000 Hours

60 x 100
BEAM ANGLE

220V-240V~
50/60Hz

UP TO 85%
ENERGY SAVINGS

NO UV/IR

SAFE
EASY TO USE

RoHS
Compliant

X

* Indent Order 需預訂

LED Weatherproof Multi Function Flood Light
LED 多功能防水泛光燈



- Adopt high quality aluminum 1070 plate as the radiator, with excellent heat dissipation, prolongs the lifespan.
採用優質鋁合金1070作散熱器，散熱表現極佳，延長使用壽命
- Series and Parallel circuit board design, improves the stability of the light.
串聯和並聯電路板設計，提高了燈的穩定性
- Constant-current LED driver, improves the stability as well as the efficiency of the fixture.
恆流LED驅動器，提高了燈具的穩定性和效率。
- Transparent Optical PC lens, with 90% photo permeability, increases the efficiency of the light.
透明光學PC透鏡具有90%的透光率，可提高光效。



LED Street Light LED 街道燈



LED Street Light LED 街道燈



MODEL 型號	CT 色溫#	BEAM ANGLE 發光角度	LUMENS 流明	CRI 顯色度	PACKING 包裝
LED Street Light 街道燈 - 30W*					
LSL-30WDL	6500K	65 x 135°	3600lm	>70	10pcs/ctn.
LSL-30WCW	2700K		3300lm		
LED Street Light 街道燈 - 50W*					
LSL-50WDL	6500K	60 x 145°	6500lm	>70	1pcs/ctn.
LSL-50WCW	2700K		6000lm		
LED Street Light 街道燈 - 75W*					
LSL-75WDL	6500K	60 x 145°	9000lm	>70	1pcs/ctn.
LSL-75WCW	2700K		8250lm		

IEC 60598

IEC 61347

IEC 62031

CE

IP65

3-YEAR WARRANTY

AC120V-277V~

UP TO 85% ENERGY SAVINGS

NO UV/IR

SAFE EASY TO USE

RoHS Compliant

* Indent Order 需預訂
Available Color Temperature: 可選色溫: 3000K/4000K/5000K/6000K

LED Street Light
LED 街道燈

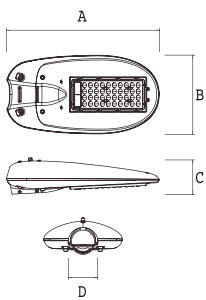

WATT 瓦數		30W	50W	75W
SIZE 呎吋	A	355mm	505mm	505mm
	B	183mm	260mm	260mm
	C	76mm	95mm	95mm
	D	50mm	62mm	62mm
SRP 建議零售價 (HK\$)		\$ 799.90	\$ 999.90	\$ 1299.90

Installation 安裝:

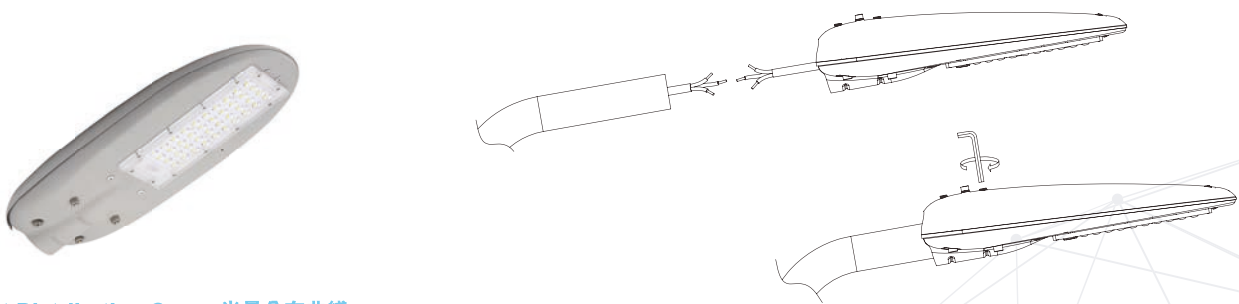

Light Distribution Curve 光量分布曲線:

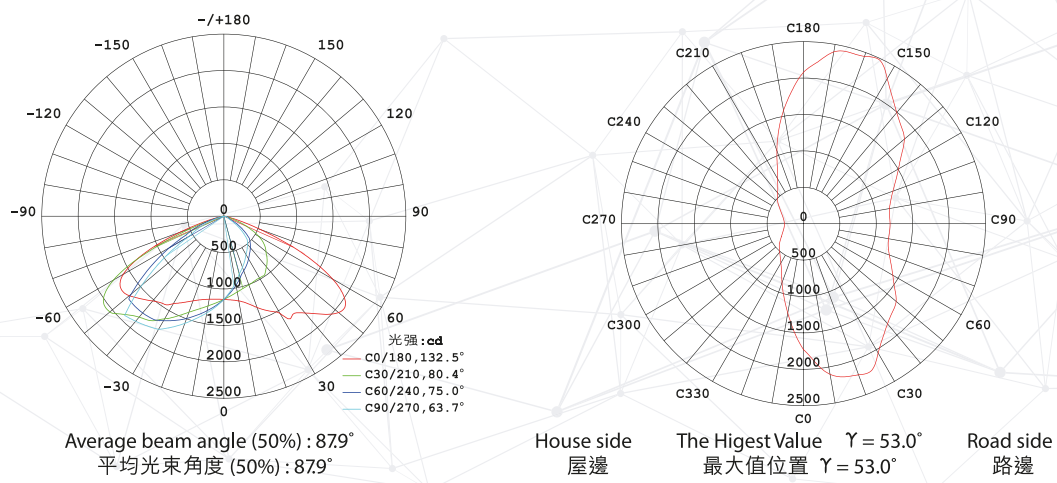



- High-efficiency LED chips with 50,000 hours average lifetime 採用達50,000小時平均壽命的高效能LED芯片
- With 0.6W surge protection, suitable for different voltages 備有0.6W防雷配置及適合多種電壓下使用
- IP65 waterproof and dustproof configuration 全天候IP65防水防塵規格
- Applicable to Type II to V light distribution 適用於Type II至V光照分佈



LED Road Light LED 公路燈



LED Road Light LED 公路燈



MODEL 型號	Watt 瓦數	CT 色溫	LUMENS 流明	CRI 顯色度	WEIGHT 重量	PACKING 包裝
-------------	------------	----------	--------------	------------	--------------	---------------

NEW LED Road Light 公路燈*

LRL-100W	100W	3000K-5700K	14500lm	70	5.5kg	1pcs/ctn.
LRL-150W	150W	3000K-5700K	21000lm		6.5kg	
LRL-200W	200W	3000K-5700K	28000lm		6.5kg	

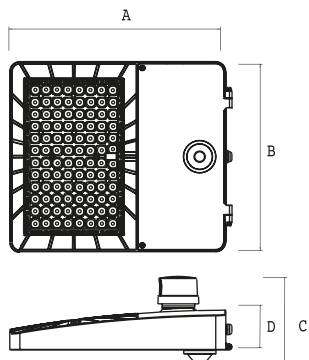

WATT 瓦數		100W	150W	200W
SIZE 呎吋	A	423mm		
	B	380mm		
	C	173mm		
	D	85mm		
SRP 建議零售價 (HK\$)		\$ 2200.00	\$ 2780.00	\$ 3180.00

CE UL cUL

DLC SAA TÜV

50,000 Hours IP66 >0.95 Power Factor

5-YEAR WARRANTY AC100V-277V~

*Indent Order 需預訂

LED Road Light
LED 公路燈

Light Distribution 光照分布:

TYPE II

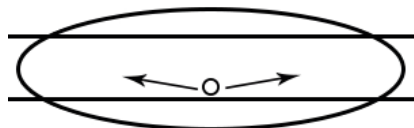

TYPE III

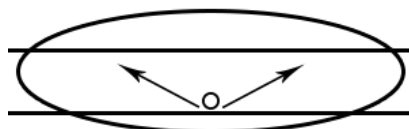

TYPE IV

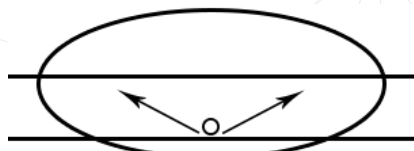

TYPE V

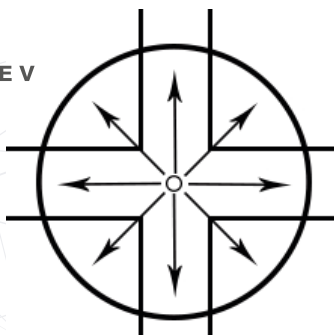



- Highly-pure aluminum housing with FIN design in IP66, elevate heat-sink performance
高純度鋁外殼，能提高散熱功能，並達IP66 防水級別
- With Explosion proof, LCF is perfect lighting choice for gas station or flammable area
LCF的防爆特性使其成為最佳的油站或易燃環境照明選擇

LED

LED Area Light
LED 區域燈



LED Area Light LED 區域燈



MODEL 型號	WATT 瓦數	CT 色溫	LUMENS 流明	CRI 顯色度	WEIGHT 重量	PACKING 包裝
----------	---------	-------	-----------	---------	-----------	------------

NEW LED Area Light 區域燈 - LMFL*

LMFL-80W	80W	4000K-6500K	10400lm	≥80	4.2kg	1pcs/ctn.
LMFL-100W	100W		13000lm		4.9kg	
LMFL-150W	150W		19500lm		4.9kg	
LMFL-200W	200W		26000lm		5.5kg	
LMFL-240W	240W		31200lm		7.8kg	
LMFL-300W	300W		39000lm		8.4kg	

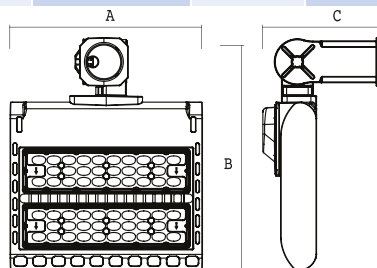

PRODUCT 產品		80W	100W	150W	200W	240W	300W
SIZE 呎吋	A	321mm				321mm	
	B	389mm				575mm	
	C	194mm				200mm	
SRP 建議零售價 (HK\$)		\$1490.00	\$1690.00	\$1890.00	\$2290.00	\$2590.00	\$3290.00

MODEL 型號	WATT 瓦數	CT 色溫	LUMENS 流明	CRI 顯色度	WEIGHT 重量	PACKING 包裝
----------	---------	-------	-----------	---------	-----------	------------

NEW LED Area Light 區域燈 - LCP * Explosion proof 防爆

LCP-75W	75W	2700K-6500K	9000lm	≥80	4.7kg	1pcs/ctn.
LCP-100W	100W		12000lm		4.7kg	
LCP-130W	130W		15600lm		5.0kg	
LCP-150W	150W		18000lm		5.0kg	

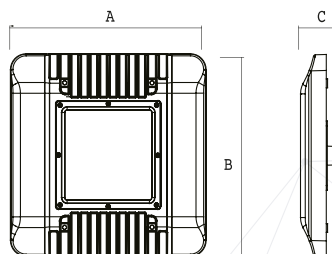

PRODUCT 產品		75W	100W	130W	150W
SIZE 呎吋	A	380mm			
	B	380mm			
	C	70mm			
SRP 建議零售價 (HK\$)		\$1390.00	\$1590.00	\$1890.00	\$1990.00

IEC 60598 IEC 62471 IEC 62031

SAA CE 50,000 Hours

IP66 >0.9 Power Factor 5-YEAR WARRANTY

AC100V-277V~

RoHS Compliant

* Indent Order 需預訂

Remarks :

Light Distribution
光照分佈

- TYPE II



- TYPE III



- 90° x 120°



CE UL 1598 50,000 Hours

IP65 DLC PHILIPS LED

SMD 3030 Tempered Glass 110° BEAM ANGLE

>0.9 Power Factor 5-YEAR WARRANTY AC100V-277V~

RoHS Compliant

* Indent Order 需預訂



- Conforms to HKFSD Licensing and Certification Command 符合香港消防處牌照及審批總區要求
- Automatic operation (turns on instantly when power is cut-off)
自動運作(電源供應終斷時立刻啟動)
- Equipped with overcharging protection 配備過度充電保護裝置
- Fuse protected 保險絲保護

LED

LED Automatic Emergency Light LED 自動應急燈



LED Automatic Emergency Light

LED 自動應急燈



NEW

**LED Twin Heads Automatic
Emergency Light***
貓頭鷹式自動應急燈*

**LED Ceiling Type Automatic
Emergency Light ***
天花式自動應急燈*

MODEL 型號	AEL-317	AEL-318
BATTERY 電池	LIR鋰電 7.4V 2000mA	
DISCHARGE DURATION 放電時間	3 Hours 小時	
CHARGING TIME 充電時間	12 Hours 小時	
INPUT VOLTAGE 輸入電壓	AC220-240V 50/60Hz	
OUTPUT 輸出功率	10W	
LED OUTPUT LED 輸出	3W x 2	
EMERGENCY OUTPUT 應急輸出	3W x 2	
CASING MATERIAL 外殼物料	Aluminum frame and fire resistant acrylic legend 鋁框架及防火膠料	
TESTING STANDARD 測試標準	HKFSD Licensing and Certification Command [PPA/104(A)4th revision]	
WARRANTY	3 YEARS	
SIZE尺寸	265mm(L) x 70mm(W) x 220mm(H)	360mm(L) x 170mm(H) cut out: 330mm(L) x 140mm(H)



NEW

**LED Emergency
Exit Sign Box***
LED 緊急出口指示燈箱*

**LED Emergency Exit Sign
plate***
LED 緊急出口指示燈牌*

MODEL 型號	LEDX-301	LEDX-201
BATTERY 電池	LIR鋰電 7.4V 2000mA	
DISCHARGE DURATION 放電時間	3 Hours 小時	
CHARGING TIME 充電時間	12 Hours 小時	
INPUT VOLTAGE 輸入電壓	AC220-240V 50/60Hz	
OUTPUT 輸出功率	10W	
LED OUTPUT LED 輸出	7W	
EMERGENCY OUTPUT 應急輸出	3W	
CASING MATERIAL 外殼物料	Aluminum frame and fire resistant acrylic legend 鋁框架及防火膠料	
TESTING STANDARD 測試標準	HKFSD Licensing and Certification Command [PPA/104(A)4th revision]	
WARRANTY	3 YEARS	
SIZE尺寸	410mm(L) x 196mm(H) x 45mm(W)	400mm(L) x 240mm(H) x 50mm(W)

Available Exit Sign Legend
可供選擇之出路燈牌

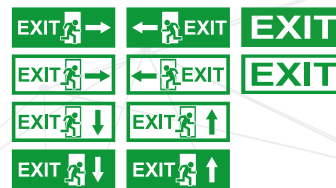

* Indent Order 需預訂
* Macau version is available
澳門版本可供選擇



- A variety of battery capacity with compat design is available, specially fit for narrow space
電池容量選擇多且輕巧，方便應用於狹小空間
- Li-ion Battery have lower self-discharge rate than nickel battery
鋰電池自我放電率較鎳電池低
- Comply with HKFSD Licensing and Certification Command [PPA/104(A)4th revision]
符合香港消防處牌照及審批總區 [PPA/104(A) 第四次修訂]

Emergency Li-ion Battery 應急鋰電池



Emergency Li-ion Battery 應急鋰電池



For Both Internal / External Driver 內置及外置驅動器:

MODEL 型號	mAH 毫安 / 小時	WATT 瓦數
NEW 100% Power Emergency Li-ion Battery - 2hr * 100% 功率應急鋰電池 - 2小時 *		
CRB-2010010	LiR 11.1V 2200mAh	10W
CRB-2020020	LiR 11.1V 4400mAh	20W
CRB-2025025	LiR 11.1V 6600mAh	25W
NEW 100% Power Emergency Li-ion Battery - 3hr * 100% 功率應急鋰電池 - 3小時 *		
CRB-3010010	LiR 11.1V 4000mAh	10W
CRB-3020020	LiR 11.1V 6600mAh	20W
CRB-3025025	LiR 11.1V 8800mAh	25W
NEW 100% Power Emergency Li-ion Battery with IC Circuit control - 2hr * 100% 功率應急鋰電池連IC電路控制 - 2小時 *		
ICRB-2010010	LiR 11.1V 2200mAh	10W
ICRB-2020020	LiR 11.1V 4400mAh	20W
ICRB-2025025	LiR 11.1V 6600mAh	25W
ICRB-2150150	LiR 37V 11000mAh	150W
NEW 100% Power Emergency Li-ion Battery with IC Circuit control - 3hr * 100% 功率應急鋰電池連IC電路控制 - 3小時 *		
ICRB-3010010	LiR 11.1V 4000mAh	10W
ICRB-3020020	LiR 11.1V 6600mAh	20W
ICRB-3025025	LiR 11.1V 8800mAh	25W
ICRB-3150150	LiR 37V 17500mAh	150W

For External Driver 外置驅動器:

MODEL 型號	mAH 毫安 / 小時	WATT 瓦數
NEW 30% Power Emergency Li-ion Battery - 2hr * 30% 功率應急鋰電池 - 2小時 *		
CRB30-2010003	LiR 11.1V 2200mAh	10W
CRB30-2020006	LiR 11.1V 4400mAh	20W
CRB30-2025008	LiR 11.1V 6600mAh	25W
NEW 30% Power Emergency Li-ion Battery - 3hr * 30% 功率應急鋰電池 - 3小時 *		
CRB30-3010003	LiR 11.1V 4000mAh	10W
CRB30-3020006	LiR 11.1V 6600mAh	20W
CRB30-3025008	LiR 11.1V 8800mAh	25W
NEW 30% Power Emergency Li-ion Battery with IC Circuit control - 2hr * 30% 功率應急鋰電池連IC電路控制 - 2小時 *		
ICRB30-2010003	LiR 11.1V 2200mAh	10W
ICRB30-2020006	LiR 11.1V 4400mAh	20W
ICRB30-2025008	LiR 11.1V 6600mAh	25W
ICRB30-2060018	LiR 25.9V 6600mAh	60W
NEW 30% Power Emergency Li-ion Battery with IC Circuit control - 3hr * 30% 功率應急鋰電池連IC電路控制 - 3小時 *		
ICRB30-3010003	LiR 11.1V 4000mAh	10W
ICRB30-3020006	LiR 11.1V 6600mAh	20W
ICRB30-3025008	LiR 11.1V 8800mAh	25W
ICRB30-3060018	LiR 25.9V 10000mAh	60W



* Indent Order 需預訂

Remarks 備註:

1. Comply with HKFSD Licensing and Certification Command [PPA/104(A)4th revision]
符合香港消防處牌照及審批總區 [PPA/104(A) 第四次修訂]
2. Tailor-made output power is available
另可訂製不同輸出功率



- Waterproof External emergency battery box is suitable for most of the luminaires
設有防水外置應急電池盒，方便應用於大部份燈具
- T8 Emergency batten set are available with different tube sizes and battery hours
配備T8 支架，可自由選擇所需應急時數及光管
- Comply with HKFSD Licensing and Certification Command [PPA/104(A)4th revision]
符合香港消防處牌照及審批總區 [PPA/104(A) 第四次修訂]

All-in-one Emergency Li-ion Battery Kit 一體式應急鋰電池套件



All-in-one Emergency Li-ion Battery Kit 一體式應急鋰電池套件



MODEL 型號	LIGHTING TIME 照明時間	WATT 瓦數
NEW All-in-one Emergency Li-ion Battery with Driver 一體式應急鋰電池連驅動器*		
ICRB-3003003	2 hrs	4W
	3 hrs	3W

IEC
62321

IEC
61347

MSDS

4W
MAX. LIGHT
SOURCE

90V-265V
50/60Hz

DC
9V-56V

RoHS
Compliant

* Indent Order with tailor made power output
需預訂並可訂製不同輸出功率

Remarks 備註:

1. Comply with HKFSD Licensing and Certification Command [PPA/104(A)4th revision]
符合香港消防處牌照及審批總區 [PPA/104(A) 第四次修訂]



EBB-260/330



WBB-330

MODEL 型號	SIZE 呎吋	EMERGENCY BATTERY 應急電池
External Emergency Li-ion Battery Box 外置應急鋰電池盒*		
EBB-260	260mm x 60mm x 60mm	11.1V 2000mAh- 11.1V 5000mAh
EBB-330	330mm x 75mm x 75mm	11.1V 5000mAh - 11.1V 10000mAh
NEW WBB-330 IP66	330mm x 230mm x 120mm	Max 37V 17500mAh

* Indent Order 需預訂



MODEL 型號	SIZE 呎吋	EMERGENCY BATTERY 應急電池	TUBE 光管
T8 Single Tube Emergency Batten Set T8 單管英式應急支架套裝*			
T8-F2	620mm x 38mm x 32mm	comply with OMNI battery below 25W 可搭配OMNI 25W以下電池	Matching with OMNI LED T8 Tube 可搭配OMNI 的 LED T8 光管
T8-F4	1230mm x 48mm x 32mm		
T8-F5	1520mm x 48mm x 32mm		
T8 Double Tube Emergency Batten Set T8 雙管英式應急支架套裝*			
T8-TF2	620mm x 78mm x 32mm	comply with OMNI battery below 25W 可搭配OMNI 25W以下電池	Matching with OMNI LED T8 Tube 可搭配OMNI 的 LED T8 光管
T8-TF4	1230mm x 78mm x 36mm		
T8-TF5	1520mm x 78mm x 36mm		

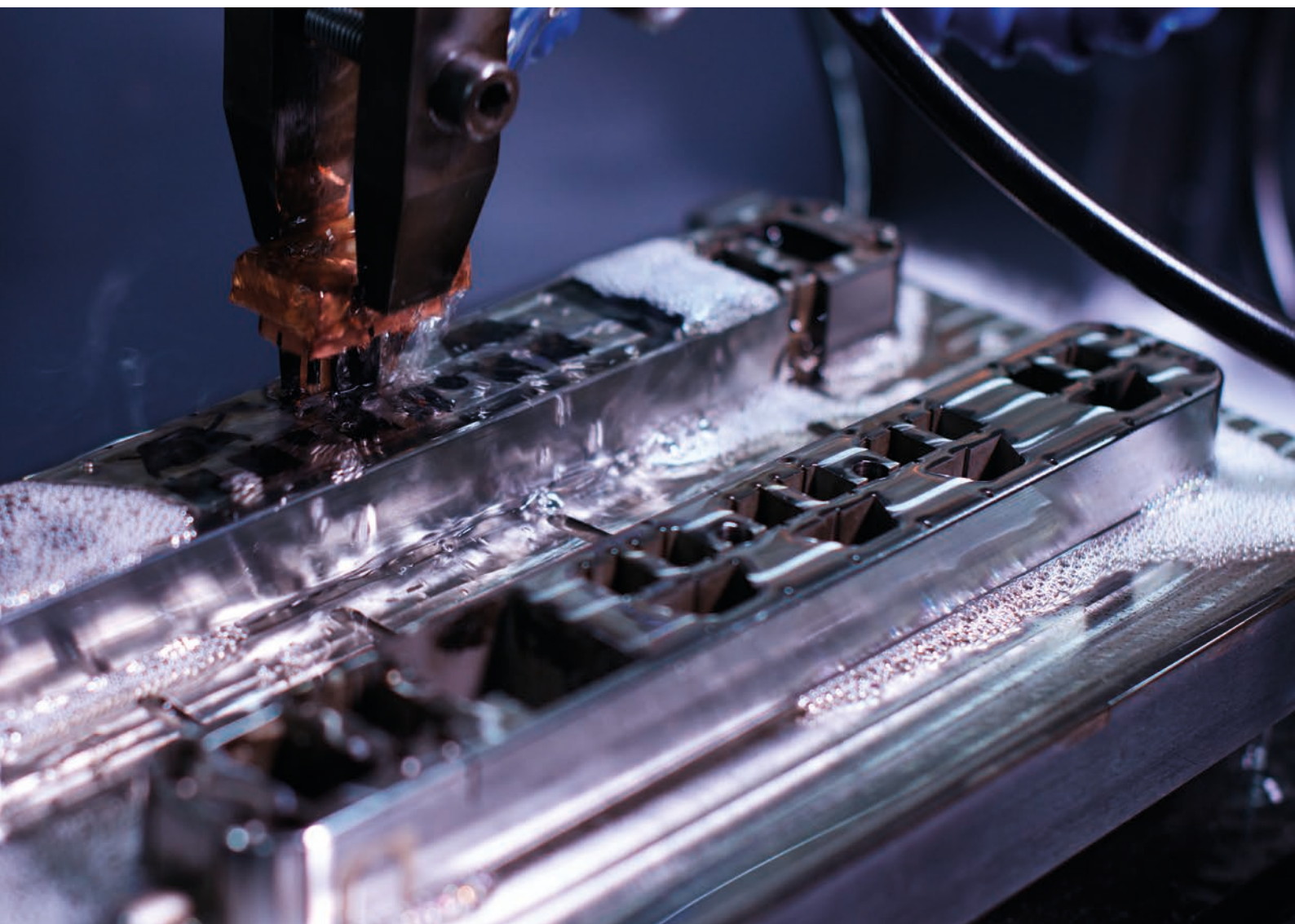

- Safety standard complied to BS1363-2
通過香港安全標準 BS1363-2
- Power cord conforms to BS6500 standard, not easy to be intenerated and distorted
電源線符合BS6500 安全標準，不易軟化及變形
- 5 Safety features
5 大安全特點

Safety Extension Sockets 安全拖板



Safety Extension Sockets 安全拖板



Safety Product Features 安全特點:



Safety standard complied to BS1363-2
通過香港安全標準 BS1363-2



Power cord conforms to BS6500 standard, not easy to be intenerated and distorted
電源線符合BS6500安全標準，不易軟化及變形



PC Alloy Casting: Max. fire resistance 750°C resistance to pressure & humidity
高質合金塑料外殼，耐熱、耐壓、防潮、耐高溫、阻燃高達750°C



Silver alloy touch point switch, high endurance and low heat elevation
銀鍍合金觸點開關，耐用、減低發熱火花



Children safety shutter
兒童安全保護門

MODEL 型號	SOCKET 插蘇位	CABLE LENGTH 電綫長度	PACKING 包裝	SRP 建議零售價
Safety Extension Sockets 安全拖板				
UK020-9	2	9 呎	12pcs/ctn.	HK\$ 99.90
UK030-9	3			HK\$ 109.90
UK040-9	4			HK\$ 119.90
UK050-9	5			HK\$ 129.90
UK060-9	6			HK\$ 139.90

More Features from USB 更多USB特點:



USB port conforms to IEC 62680 standard
USB通過IEC62680安全標準



Total USB output = 5V-3.1A
USB總輸出=5V-3.1A

MODEL 型號	SOCKET 插蘇位	USB CHARGER USB 充電	CABLE LENGTH 電綫長度	PACKING 包裝	SRP 建議零售價
NEW Safety Extension Sockets 安全拖板					
UK043-10	4	3	10 呎	12pcs/ctn.	HK\$ 148.00

NEW

BS 1363-2

CE

RoHS Compliant

1 YEAR WARRANTY

Safety Extension Sockets
安全拖板

BS 1363-2

BS 6500

IEC 62680

CE

RoHS Compliant

1 YEAR WARRANTY

USB SMART CHARGER



- Insulation plug 絕緣插腳
- Built-in fuse BS1362 內附BS1362 保險絲
- Compliance with British Standard BS 1363A 符合英國標準BS 1363A
- Made from ABS anti-breakage plastic 使用ABS 不碎膠*

13A British Standard Sockets 13A 英標插頭



* Except model: UKP-003

13A British Standard Sockets
13A 英標插頭



13A British Standard Sockets 13A英標插頭

BS
1363-1



Model No 型號: UKP-301
SRP 建議零售價 (HK\$)
\$22.90



Model No 型號: UKP-302
SRP 建議零售價 (HK\$)
\$24.90



Model No 型號: UKP-501
SRP 建議零售價 (HK\$)
\$22.90



Model No 型號: UKP-502
SRP 建議零售價 (HK\$)
\$24.90

13A British Standard Sockets
13A 英標插頭



Model No 型號: UKP-001
SRP 建議零售價 (HK\$)
\$8.50



Model No 型號: UKP-003 (Bakelite/電木)
SRP 建議零售價 (HK\$)
\$8.50

NEW



Model No 型號: UKP-202
SRP 建議零售價 (HK\$)
\$14.90



Model No 型號: UKP-214
SRP 建議零售價 (HK\$)
\$59.90

BS
1363-3

IEC
60950

USB
Max 2.1A



- Portable and convenient design of 2 / 3 pieces in 1 with storage case
設計輕巧方便，1套包含2 / 3 件配件置於收納盒內
- Universal adapter works in most country worldwide
環球轉插能適用於大部份國家
- Built-in safety shutters with fuse protect 內置兒童安全保護門及保險絲



Universal Travel Adapter 環球旅行轉插

Remarks: These Models are not for HK market
備註：此產品不適用於香港市場

Universal Travel Adapter 環球旅行轉插



MODEL 型號	額定輸入電壓 Rated Input Voltage	PACKING 包裝
Universal Travel Adapter 環球旅行轉插		
WUA-004	3A 250V-6A 125V-50/60Hz	120pcs/ctn

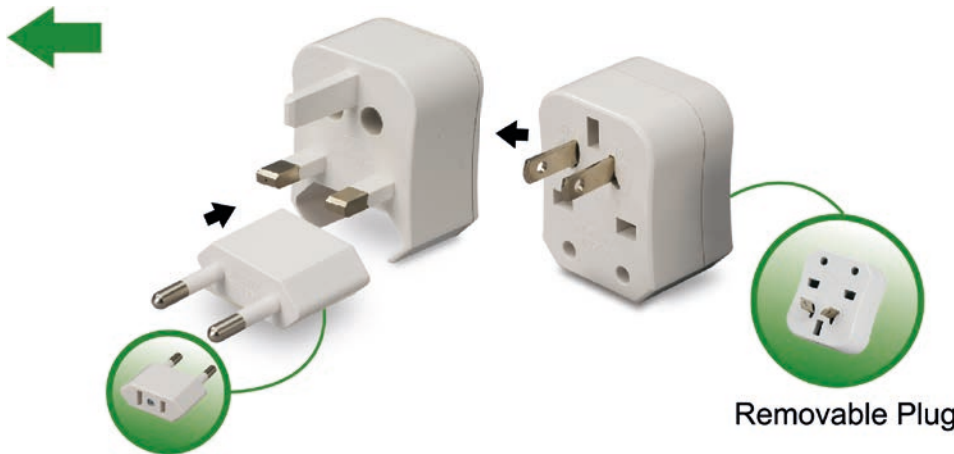

Removable Plug

禮品及贈品

可供絲印商標

Logo printing service - available

MODEL 型號	額定輸入電壓 Rated Input Voltage	PACKING 包裝
Universal Travel Adapter with USB 環球旅行轉插帶USB		
WUA-005	3A 250V-6A 125V-50/60Hz	60pcs/ctn

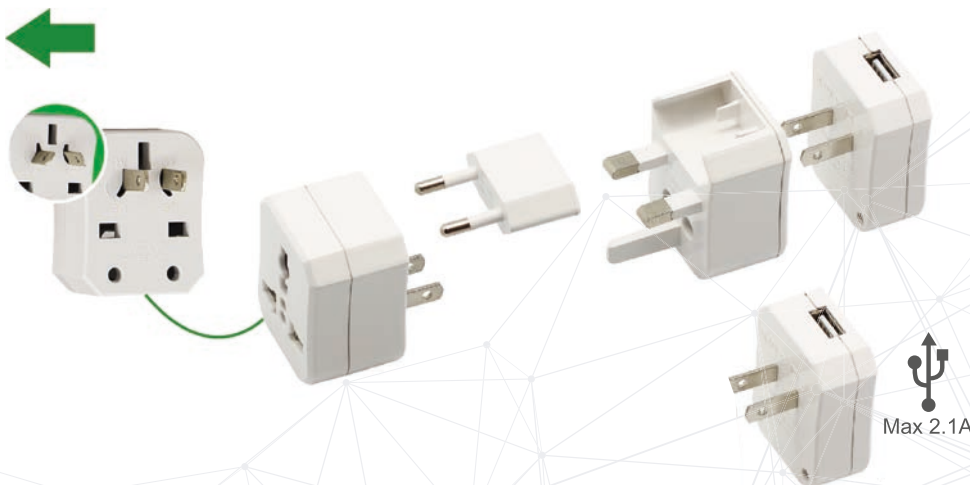

禮品及贈品

可供絲印商標

Logo printing service - available



Europe, Australia, New Zealand, Asia, Indonesia, Philippines, Vietnam, South Korea, Africa.



China, Mongolia, South-East Asia, Thailand, Australia, New Zealand, Part of South America.



USA, Canada, Japan, Taiwan, Caribbean Islands, Part of South America.



United Kingdom, Ireland, Singapore, Malaysia, Hong Kong, Macau, Middle East.

Universal Travel Adapter
環球旅行轉插

Symbol Index 標籤索引

The International Electrotechnical Commission (IEC) Standard

國際電工委員會認證

The world's leading organization that prepares and publishes International Standards for all electrical, electronic and related technologies

全球領先的認證組織，為所有電器、電子及相關技術制定及出版國際標準

	<p>Lamp caps and holders together with gauges for the control of interchangeability and safety. 燈頭，燈座及量度器互換性和安全控制。</p>		<p>The standard for assessment of blue light hazard to light sources and luminaires. 針對光源和灯具所發出的藍光危害評估標準。</p>
	<p>General requirements for luminaires, incorporating electric light sources for operation from supply voltages up to 1000V. 對於一般燈具的要求，及對供電電源不超過1000V 的特定類型燈具詳細要求。</p>		<p>for general lighting services with supply voltages not exceeding 50 V a.c. r.m.s. or 120 V ripple free d.c. - Safety specifications 適用於需搭配外部控制器提供 低電壓輸入電源之LED 燈泡，而外部控制器分為低頻 (50Hz/60Hz) 及高頻 (AC electronic)2 種。</p>
	<p>Applicable to mains-powered or battery-powered information technology equipment with a rated voltage not exceeding 600 V. 適用於主電源或電池電源資訊產品 (含商業電子設備) 及其週邊產品，且額定電壓低於600V。</p>		<p>European Conformity Mark - Standard for the product that complies with the essential requirements of the relevant European health, safety and environmental protection legislation. 歐洲統一標誌 - 產品符合歐洲健康、安全及環保法規的基本標準。</p>
	<p>Particular safety requirements for electronic controlgear. 電子控制裝置的特殊安全規範。</p>		<p>Underwriters Laboratories Inc., a nonprofit inspection agency in the United States. It mainly regulate the safety of machinery, equipment and materials to protect customers from any accidents such as fires. 全稱 Underwriters Laboratories Inc.，是美國的非營利性檢查機關。主要對機械、器材、材料的安全性進行監督管理，以防止火災等事故危害消費者生命安全。</p>
	<p>LED modules for general lighting - safety specifications. LED 模塊用於普通照明 - 安全規範。</p>		<p>Electromagnetic compatibility test is the comprehensive assessment of the interference (EMI) and anti-interference ability (EMS) of electronic products in the electromagnetic field. It can evaluate the impact of electromagnetic radiation generated by electrical products on human, public power grid and others. 電磁相容測試，指的是對電子產品在電磁場方面干擾大小 (EMI) 和抗干擾能力 (EMS) 的綜合評定，目的是檢測電器產品所產生的電磁輻射對人體、公共電網以及其他正常工作之電器產品的影響。</p>
	<p>Electrotechnical products - Determination of levels of six regulated substances (lead, mercury, cadmium, hexavalent chromium, polybrominated biphenyls, polybrominated diphenyl ethers) 用於檢測電氣電子設備中六種受管制物質的含量，包括(鉛 (Pb)、汞 (Hg)、鎘 (Cd)、六價鉻 (Cr (VI))、多溴聯苯 (PBB) 和多溴二苯醚 (PBDE))。</p>		<p>accredited by the Joint Accreditation Service of Australia and New Zealand (JAS-ANZ) as a third party certification body to issue of Certificates of Approval for declared and non-declared electrical equipment that has proven to comply with the safety requirements of the applicable Australian Standard. 經澳洲和紐西蘭聯合認證體系 (JAS-ANZ) 核准的協力廠商認證機構，有資格給強制認證電氣設備和非強制認證電氣設備頒發認證證書，證明這些設備符合現行的澳洲標準規定的安全要求。</p>
	<p>Photobiological safety of lamps and lamp systems. 燈和燈系統的光生物安全性。</p>		<p>The cUL mark applies to products intended for the Canadian market that have been tested and found to comply with the requirements of CAN/CSA 22.1-12, which is the Canadian Electrical Code issued by the Canadian Standards Association. cUL 標誌適用於通過並符合加拿大標準協會頒布的加拿大電氣規範 CAN / CSA 22.1-12 要求的加拿大市場產品。</p>
	<p>Assessment of lighting equipment related to human exposure to electromagnetic fields. 用以評估人體暴露在照明設備所造成的空間電磁場允許值標準。</p>		
	<p>Safety and interchangeability requirements intended for domestic and similar general lighting, which rated below 60W and range from 50V up to 250V. 用於家庭及類似環境的普通照明安全性和互換性要求，此燈具不高於60W 並由50V 到250V。</p>		
	<p>Standard for power delivery system covering all elements of a USB system including: Hosts, Devices, Hubs, Chargers and cable assemblies. 涵蓋USB 系統所有元件的供電系統標準，包括：主機，驅動器，集線器，充電器和電線組件。</p>		
	<p>Double-capped LED fluorescent lamps - safety specifications. 雙端LED 光管 - 安全規範。</p>		



“The Design Lights Consortium” 是由公用事業公司和地區性能效機構組成的聯合組織發起的一項自願性的能效計畫。在認證高能效照明品質和性能方面處於領先地位。DLC 認證產品適用於尚未被“能源之星”標準覆蓋的LED/SSL商業照明燈具
The DesignLights Consortium (DLC) is a partner of local energy efficiency groups and utility companies. It always be the leader in certification of high power lighting quality and performance. The DLC applies only to LED/SSL commercial lighting products that are not included in the Energy Star® program.



Restriction of the use of certain hazardous substances
禁止使用數種有害物質。



WEEE Recycling Logo - prevents careless disposal of electrical products.
歐盟WEEE 回收標誌- 禁止消費者隨意丟棄廢電子電機產品。



Dimmable bulb (appropriate dimmer is needed).
可調光燈膽(需搭配適當調光器)。



Non-dimmable bulb.
非調光燈膽。



Safety certification logo customized by TÜV Germany for component products and it is recognized by Germany and Europe.
TüV標誌是德國TüV專為元器件產品定制的一個安全認證標誌，在德國和歐洲得到廣泛的接受。



material safety data sheet(MSDS) is a technical document which provides detailed and comprehensive information on a controlled product related to: health effects of exposure to the product • hazard evaluation related to the product's handling, storage or use • emergency procedures.

化學品安全說明書，是用來闡明產品的理化特性，例如：接觸產品對健康的影響，產品處理、儲存或使用的危險評估，緊急程序。



Standard for protection against solid objects and liquids
對抵禦固體及液體程度之標準

First Digit 第一個數字

“5”

Ingress of dust is not entirely prevented, but it must not enter in sufficient quantity to interfere with the satisfactory operation of the equipment.
不可能完全阻止灰塵進入，但灰塵進入的數量不會對設備造成傷害



PSE (Product Safety of Electrical Appliance & Material) is a compulsory certification for electrical products import to Japan.
PSE (Product Safety of Electrical Appliance & Material) 是電氣用品進入日本市場的強制性驗證制度



“6”
totally protected against dust
能完全抵禦塵埃

Second Digit 第二個數字

“4”

protected against water splashing the enclosure from any direction
可抵受從任何方向射來的水花

“5”

protected against low pressure jets of water from all directions
可抵受來自所有方向的低壓水柱噴射



A Safety Standard for 13 A plugs, socket-outlets, adaptors and connection units.
13 A 插頭，插座，適配器和連接單元的安全標準。



13A plugs, socket-outlets, adaptors and connection units. Specification for adaptors
13A插頭，插座，適配器和連接單元的安全標準。適配器規格



A Safety Standard for Electric cables. Flexible cords rated up to 300/500 V.
電線安全標準，其額定功率可高達300/500 V。



No ultraviolet and infrared rays.
不含紫外線及紅外線。

“6”

Water projected in powerful jets (12.5 mm nozzle) against the enclosure from any direction shall have no harmful effects.
可抵受來自所有方向的高壓水柱噴射

Average lifetime 平均壽命:
Computed at 5 hours per day when used in proper condition.
在正確環境使用下，每天使用5小時計算

Authorized Distributor



YATAI INTERNATIONAL CORPORATION

Yatai Tower, 2673-C, Rafael Alunan Street,
Interior Road, Malate, Manila, Philippines
Tel. No.: +63-2-567-0000 Fax. No.: +63-2-567-2342
Email: info@omni.net.ph
www.omniphilippines.com.ph

OMNI ELECTRICAL (HK) CO. LTD.

Room D, 18/F, Blk. 1, Vigor Ind. Bldg.,
49-53 Ta Chuen Ping St., Kwai Chung, Hong Kong
Tel. No.: +852-2305-4478 Fax. No.: +852-3971-0647
Email: sales@omni-hk.com
www.omni-hk.com

OMNI ELECTRICAL AND LIGHTING (AUSTRALIA) PTY., LTD.

17 Lacey St Croydon Vic 3136 Australia
Tel. No.: +61-1300-333-001 Fax. No.: +61-1300-333-002
Email: sales@omni-au.com
www.omni-au.com

YATAI (CHINA) ELECTRICAL CO., LTD.

5th Floor, No.5 Building, Guanyinshan International
Business Park, Siming District, Xiamen, China
Tel. No.: +86-592-5058882 Fax. No.: +86-592-5033882
Email: lighting@yataichina.com