



Product Catalogue 產品目錄
2021-2022

About Us 關於我們

Company Background 公司背景

Omni Electrical & Lighting is wholly owned by Yatai International Corporation, which celebrates its 20th anniversary in 2016. Based in Asian with 100 thousand square feet world-class manufacturing facilities and thousands of employees, Yatai is one of the few names in lighting & electrical industry with capabilities in R&D, manufacturing, selling and branding under one roof.

歐麗電業母公司 - 亞泰國際股份有限公司至今成立已超過20年，一直扎根亞洲，面向世界，成為區內生產優質照明和專業電業產品的企業。除了擁有占地達10萬平方呎、數千名員工的現代化生產設備的廠房外，亦是亞洲少數電業品牌能做到研發、生產、銷售及品牌一站式管理，絕對傲視同群！

Vision Statement 願景

To become one of the most trusted, pioneer Asian world brand in electrical & lighting, as the leading supplier of safe, innovative, customer-centric, eco-friendly and superior products at affordable price.

成為亞洲區內世界級電工及照明品牌，作為業內領先供應商，提供安全、創新、以客為主、環保及大眾化的優質產品。

Core Value 核心價值

Yatai and Omni continue to evolve and expand its business while remaining true to the core value represented by the eight petals of Omni logo, namely: accountability, integrity, teamwork, competence, quality, commitment, innovation and passion to continuously satisfy consumer needs.

亞泰及歐麗本著其核心價值發展至今。而歐麗標誌上的八片花瓣，正代表了我們八個核心價值：問責、誠信、團隊合作、能力、質量、承諾、創新和激情，以不斷滿足消費者的需求。

Mission Statement 營運宗旨

To create long-term benefits for customers by delivering excellent products, creating value and services to Asian countries through innovation and cutting-edge technology, state-of-art manufacturing facilities, professional teams and superior craftsmanship.

以卓越的產品及服務、創新及先進的技術、完備的生產設備、專業的團隊及優秀的工藝為亞洲區客戶帶來長遠的利益及增值。



Quality Assurance 質量監控

We value quality assurance a lot and put into action to obtain various certifications issued by worldwide professional authorities, including IEC, DAF by German, UL/FCC by US, Energy Star & CE by EU, JIS by Japan and 3C by China in lighting products. For electrical products, we accredited by HKEP(S)R, BS1363A by UK, CE by EU, 3C by China, SS167 by Singapore, MS589 by Malaysia and IEC. We dedicate ourselves to providing our consumers with premium quality and safety products.

我們非常重視產品及服務的質量，以國際級水平為標準，照明產品榮獲國際標準電工委員會IEC、德國DAF實驗室、美國UL/FCC、Energy Star、歐盟CE、日本JIS、中國3C等品質標準和認證，產品獲得全球超過40個主要國家認證。電工產品更榮獲香港HKEP(S)R、英國BS1363A、歐洲CE、中國3C、新加坡SS167、馬來西亞MS589、符合國際標準電工委員會IEC等權威認證，產品無論在質量及安全上都是無容置疑。

Innovation 創新意念

Innovation and new product development is our foundation by innumerable investment. To uplift the efficiency of R&D, we have 300 product engineers, 10 specialized testing laboratories for product function and environmental standard. Our factory is operated and managed by ERP system with up-to-date facilities to ensure our products attaining highest international standard. As a leading company in Asia, we have more than 300 patents in professional electrical low voltage power adaptors covering various areas of products.

我們在產品開發及創新方面投入大量資源，包括擁有設計工程師逾三百名的開發團隊，建立了十個專門的技術研發、性能檢測及環保檢測等專業實驗室，提升研發的成效。全廠採用ERP系統嚴格管理生產流程，並不斷投入和更新設備系統，使我們有能力在最快時間完成設計和發展新產品，令產品性能指標達到國際最高標準。在電工產品方面，我們擁有300多項專業低壓電源适配器的專利，並涵蓋不同類別產品。

Awards and Endorsements 獎項及認證

- Asia Excellence Award 2012, 2014 & 2016
- Roadshow Best Loved Brands Award 2014
- Registered supplier of HKSAR EMSD (No.: S0685)
- Registered Electrical Contractor (No.: 031322)
- 榮獲2012、2014及2016年度亞洲卓越品牌大獎
- 榮獲ROADSHOW一路最愛品牌大獎
- 為香港機電工程署註冊供應商 (No.: S0685)
- 為香港註冊電業承辦商 (No.: 031322)





Contents 目錄

LED General Lighting Series LED 一般照明系列

LED A Bulb LED A 形燈膽	P.5
LED Globe Bulb LED 球形膽	P.6
LED Pinlight LED 插拔管燈	P.7-8
LED Candle Bulb LED 蠟燭燈	P.8
LED Flat Lamp LED 簡約頂燈	P.9
LED Dimmable Bulb LED 調光燈膽	P.10

LED Industrial and Commercial Lighting Series LED 工業及商業照明系列

LED T8 Tube LED T8 光管	P.11,13
LED T8 Micro Sensor Plastic Tube LED T8 微波光管	P.12
LED T5 Tube LED T5 光管	P.14-15
LED MR16 Spotlight LED MR16 射燈	P.16-19
LED Panel Light LED 三色平板燈	P.20-21
LED Linear Light LED 線條燈	P.22
LED Adjustable Downlight LED 可調角度筒燈	P.23
LED Ultra Slim Downlight LED 超薄身筒燈	P.24
LED Integrated Recessed Downlight LED 一體化嵌入式筒燈	P.25
LED High Power Bulb LED 高效能柱燈	P.26
LED Heavy Duty Globe LED 高效能柱燈	P.27

LED Outdoor Lighting Series LED 戶外照明系列

IP65 LED High Bay Lamp LED 高樓底燈	P.28-30
IP65 LED Par Lamp LED 防水PAR膽	P.31
IP65 LED Bulb LED 防水燈膽	P.32
IP65 LED Weatherproof Light LED 防水面包燈	P.33-34
IP65 LED Micro Sensor Weatherproof Light LED 微波感應防水面包燈	P.35
IP65 LED Weatherproof Fixture (Ultra Slim Linear Light) LED 一體化纖巧三防支架	P.36
IP65 LED Weatherproof Flood Light LED 耐用版防水泛光燈	P.37
IP66 LED Jupiter Stadium Light LED 室外運動場所照明燈	P.38
IP65 LED Street Light LED 街道燈	P.39
IP66 LED Area Light 區域燈	P.40

LED Emergency Lighting Series LED 應急照明系列

Emergency Li-ion Battery 應急鋰電池	P.41-42
External Emergency Li-ion Battery Box 外置應急鋰電池盒	P.43
T8 Single/ Double Tube Emergency Batten Set T8 單管/雙管仿英式應急支架套裝	P.43
Emergency Weatherproof Batten 應急三防支架	P.43

Electrical Product Series 電工產品系列

13A USB Safety Extension Sockets 13A USB 獨立開關安全拖板	P.44-45
13A Safety Extension Sockets 13A 獨立開關安全拖板	P.46
13A British Standard Sockets 13A 英標插頭	P.47
Universal Travel Adapter 環球旅行轉插 (For Export Only 只供出口)	P.48

LED Other Products LED 其他產品

LED Other Products LED 其他產品	P.49-52
-----------------------------	---------

Appendix 附錄

Symbol Index 標籤索引	P.53-54
-------------------	---------

LED A Bulb LED A 形燈膽



LED A Bulb
LED A 形球膽

vs

Incandescent
鎢絲膽

6W → 40W
9W → 60W
12W → 90W
15W → 100W

LED A50 Bulb 6W



MODEL 型號	CT 色溫	LUMENS 流明	LAMP BASE 燈腳	AVE. LIFE 平均壽命	PACKING 包裝
LLA50E27-6W-DL	6500K	500lm	E27	20,000hrs	48pcs/ctn.
LLA50E27-6W-WW	2700K	450lm			
LLA50B22-6W-DL	6500K	500lm	B22		

LED A60 Bulb 9W

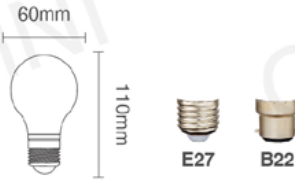

MODEL 型號	CT 色溫	LUMENS 流明	LAMP BASE 燈腳	AVE. LIFE 平均壽命	PACKING 包裝
LLA60E27-9W-DL	6500K	800lm	E27	20,000hrs	48pcs/ctn.
LLA60E27-9W-CW	4000K	780lm			
LLA60E27-9W-3K	3000K	750lm			
LLA60E27-9W-WW	2700K	750lm			
LLA60B22-9W-DL	6500K	800lm	B22		
LLA60B22-9W-WW	2700K	750lm			

LED A65 Bulb 12W

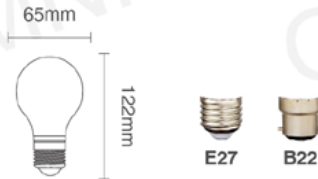

MODEL 型號	CT 色溫	LUMENS 流明	LAMP BASE 燈腳	AVE. LIFE 平均壽命	PACKING 包裝
LLA65E27-12W-DL	6500K	1100lm	E27	20,000hrs	48pcs/ctn.
LLA65E27-12W-WW	2700K	1000lm			
LLA65B22-12W-DL	6500K	1100lm	B22		

LED A70 Bulb 15W

MODEL 型號	CT 色溫	LUMENS 流明	LAMP BASE 燈腳	AVE. LIFE 平均壽命	PACKING 包裝
LLA70E27-15W-DL	6500K	1400lm	E27	20,000hrs	48pcs/ctn.
LLA70E27-15W-WW	2700K	1300lm			

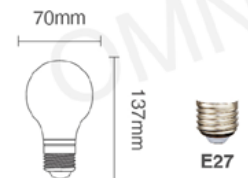

LED Globe Bulb

LED 球形膽

LED Globe Bulb LED 球形膽 vs Incandescent 鎢絲膽

4W → 30W
12W → 90W
18W → 120W

LED General Lighting Series
LED 一般照明系列

LED G45 Globe Bulb 4W

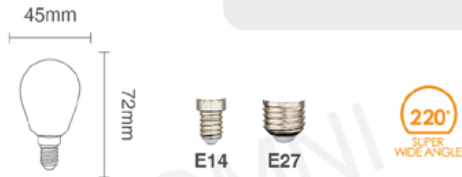

MODEL 型號	CT 色溫	LUMENS 流明	LAMP BASE 燈腳	AVE. LIFE 平均壽命	PACKING 包裝
LLG45E14-4W-DL	6500K	350lm	E14	20,000hrs	48pcs/ctn.
LLG45E14-4W-WW	2700K	320lm			
LLG45E27-4W-DL	6500K	350lm	E27		
LLG45E27-4W-WW	2700K	320lm			

LED G95 Globe Bulb 12W



MODEL 型號	CT 色溫	LUMENS 流明	LAMP BASE 燈腳	AVE. LIFE 平均壽命	PACKING 包裝
LLG95E27-12W-DL	6500K	1050lm	E27	20,000hrs	24pcs/ctn.
LLG95E27-12W-CW	4000K	1030lm			
LLG95E27-12W-WW	2700K	1000lm			
LLG95B22-12W-DL	6500K	1050lm	B22		
LLG95B22-12W-WW	2700K	1000lm			

LED G120 Globe Bulb 18W



MODEL 型號	CT 色溫	LUMENS 流明	LAMP BASE 燈腳	AVE. LIFE 平均壽命	PACKING 包裝
LLG120E27-18W-DL	6500K	1600lm	E27	20,000hrs	12pcs/ctn.
LLG120E27-18W-CW	4000K	1600lm			
LLG120E27-18W-WW	2700K	1500lm			
LLG120B22-18W-DL	6500K	1600lm	B22		
LLG120B22-18W-WW	2700K	1500lm			

LED Pinlight LED 插拔管燈

Registered Patent 註冊專利:
Appearance Patent 外觀專利設計 ZL201430334074.4
China Utility Model Patent 中國實用新型專利 ZL2014205203.0

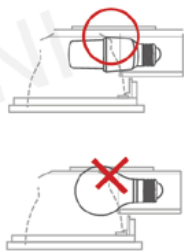



LED Pinlight
LED 插拔管燈

VS



Compact
Fluorescent Lamp
燈管

7W → 13W
9W → 18W
12W → 26W

LED Pinlight 7W



MODEL 型號	CT 色溫	LUMENS 流明	LAMP BASE 燈腳	AVE. LIFE 平均壽命	PACKING 包裝
LPLE14-7W-DL	6500K	600lm	E14	20,000hrs	48pcs/ctn.
LPLE14-7W-WW	2700K	550lm			
LPLE27-7W-DL	6500K	600lm	E27		
LPLE27-7W-WW	2700K	550lm			
LPLG24D-7W-DL	6500K	600lm	G24D		
LPLG24D-7W-CW	4000K	580lm			
LPLG24D-7W-WW	2700K	550lm			

LED Pinlight 9W



MODEL 型號	CT 色溫	LUMENS 流明	LAMP BASE 燈腳	AVE. LIFE 平均壽命	PACKING 包裝
LPLE14-9W-DL	6500K	840lm	E14	20,000hrs	48pcs/ctn.
LPLE14-9W-WW	2700K	810lm			
LPLE27-9W-DL	6500K	840lm	E27		
LPLE27-9W-WW	2700K	810lm			
LPLG24D-9W-DL	6500K	840lm	G24D		
LPLG24D-9W-CW	4000K	830lm			
LPLG24D-9W-WW	2700K	810lm			

LED Pinlight 12W



MODEL 型號	CT 色溫	LUMENS 流明	LAMP BASE 燈腳	AVE. LIFE 平均壽命	PACKING 包裝
LPLE27-12W-DL	6500K	1100lm	E27	20,000hrs	48pcs/ctn.
LPLE27-12W-CW	4000K	1050lm			
LPLE27-12W-WW	2700K	1000lm			
LPLG24D-12W-DL	6500K	1100lm	G24D		
LPLG24D-12W-CW	4000K	1050lm			
LPLG24D-12W-WW	2700K	1000lm			

LED Pinlight 插拔管燈

-Ultra Slim design for different lampshades
纖巧時尚設計，易於配合不同燈飾及燈具

-300° wide beam angle
300° 廣闊發光角度

-50% energy savings when compare to CFL pinlights
比傳統螢光管燈節能50%

-Mercury free
不含水銀

-Less heat emission
熱能釋放量低

-20,000 hours of average lifetime
平均壽命可達20,000小時



LED Pinlight 7W



MODEL 型號	CT 色溫	LUMENS 流明	LAMP BASE 燈腳	AVE. LIFE 平均壽命	PACKING 包裝
LPLG23-7W-DL	6500K	600lm	G23*	20,000hrs	48pcs/ctn.
LPLG23-7W-CW	4000K	580lm			
LPLG23-7W-WW	2700K	550lm			

*G23 5W/9W are available for order 可供訂購

LED Candle Bulb LED 蠟燭燈

Clear Cover 清面 6W

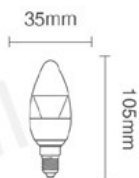

MODEL 型號	CT 色溫	LUMENS 流明	LAMP BASE 燈腳	AVE. LIFE 平均壽命	PACKING 包裝
LCC35E14-6W-DL	6500K	400lm	E14	20,000hrs	48pcs/ctn.
LCC35E14-6W-WW	2700K	370lm			

Frosted Cover 磨砂面 6W

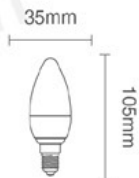

MODEL 型號	CT 色溫	LUMENS 流明	LAMP BASE 燈腳	AVE. LIFE 平均壽命	PACKING 包裝
LCF35E14-6W-DL	6500K	400lm	E14	20,000hrs	48pcs/ctn.
LCF35E14-6W-WW	2700K	370lm			

LED Flat Lamp

LED 簡約頂燈

12W → 23W
22W → 32W
30W → 42W

LED Flat Lamp 12W



MODEL 型號	CT 色溫	LUMENS 流明	LAMP BASE 燈腳	AVE. LIFE 平均壽命	PACKING 包裝
LFE27-12W-DL	6500K	1100lm	E27	20,000hrs	10pcs/ctn.
LFE27-12W-WW	2700K	1050lm			
LFB22-12W-DL	6500K	1100lm	B22		

LED Flat Lamp 22W



MODEL 型號	CT 色溫	LUMENS 流明	LAMP BASE 燈腳	AVE. LIFE 平均壽命	PACKING 包裝
LFE27-22W-DL	6500K	1900lm	E27	20,000hrs	10pcs/ctn.
LFE27-22W-WW	2700K	1800lm			
LFB22-22W-DL	6500K	1900lm	B22		

LED Flat Lamp 30W



MODEL 型號	CT 色溫	LUMENS 流明	LAMP BASE 燈腳	AVE. LIFE 平均壽命	PACKING 包裝
LFE27-30W-DL	6500K	2500lm	E27	20,000hrs	6pcs/ctn.
LFE27-30W-CW	4000K	2400lm			
LFE27-30W-WW	2700K	2400lm			
LFB22-30W-DL	6500K	2500lm	B22		
LFB22-30W-WW	2700K	2400lm			

LED Dimmable Bulb LED 調光燈膽

LED Dimmable A Bulb 調光A形燈膽

A60 Bulb A60 調光燈膽 9W

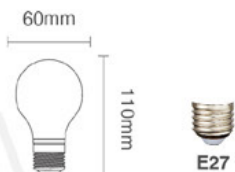

MODEL 型號	CT 色溫	LUMENS 流明	LAMP BASE 燈腳	AVE. LIFE 平均壽命	PACKING 包裝
LLA60E27D-9W-DL	6500K	850lm	E27	20,000hrs	48pcs/ctn.
LLA60E27D-9W-WW	2700K	800lm			

A65 Bulb A65 調光燈膽 12W



MODEL 型號	CT 色溫	LUMENS 流明	LAMP BASE 燈腳	AVE. LIFE 平均壽命	PACKING 包裝
LLA65E27D-12W-DL	6500K	1000lm	E27	20,000hrs	48pcs/ctn.
LLA65E27D-12W-WW	2700K	900lm			

IEC 62471 IEC 62560



CRI >80



UP TO 85% ENERGY SAVINGS

10 YEARS OF LIFE



LED Dimmable Candle Bulb 調光蠟燭燈

Clear Clover 清面 6W

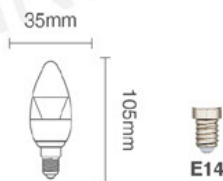

MODEL 型號	CT 色溫	LUMENS 流明	LAMP BASE 燈腳	AVE. LIFE 平均壽命	PACKING 包裝
LCC35E14D-6W-DL	6500K	380lm	E14	20,000hrs	48pcs/ctn.
LCC35E14D-6W-WW	2700K	350lm			

Frosted Cover 磨砂面 6W

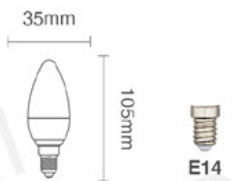

MODEL 型號	CT 色溫	LUMENS 流明	LAMP BASE 燈腳	AVE. LIFE 平均壽命	PACKING 包裝
LCF35E14D-6W-WW	2700K	350lm	E14	20,000hrs	48pcs/ctn.

IEC 62471 IEC 62560



CRI >80



UP TO 85% ENERGY SAVINGS

10 YEARS OF LIFE



LED A Bulb LED A形球膽 vs Incandescent 鎢絲膽

9W → 60W
12W → 80W

LED Candle Bulb LED 蠟燭燈 vs Incandescent 鎢絲燈

6W → 40W

LED T8 Tube LED T8 光管

LED T8 Plastic Tube
LED T8 全塑光管 AC220V

LED T8 Plastic Tube
LED T8 全塑光管

VS

Fluorescent Tube
熒光管

10W → 18W
14W → 30W
18W → 36W
23W → 58W



MODEL 型號	FT 呎	CT 色溫	LUMENS 流明	BEAM ANGLE 發光角度	LAMP BASE 燈腳	CRI 顯色度	PACKING 包裝
LT8-10W	2ft	3000K 4000K 6500K	900lm	>200°	G13	>80	30pcs/ctn.
LT8-14W	3ft	3000K 4000K 6500K	1250lm				
LT8-18W	4ft	3000K 4000K 6500K	1800lm				
LT8-23W	5ft	3000K 4000K 6500K	2200lm				

Product Standard 產品標準

- EN 55015
- EN 61547
- EN 61000-3-2
- EN 61000-3-3
- EN 62776
- EN 62471
- EN 62493
- IEC/TR 62778



- Unique Nano PC Design 獨特的納米PC設計
- Soft light output 輸出柔和光線
- Mercury free 不含水銀
- 100% recyclable material 100%可回收材料
- Anti blue light test passed 通過抗藍光測試
- Easy installation 簡易安裝

Dimension 產品尺寸

FT 呎	Dimension 尺寸 (mm)	
	A	B
2ft	588	29
3ft	893	29
4ft	1198	29
5ft	1498	29



LED T8 Micro Sensor Plastic Tube

LED T8微波感應全塑光管



8W → 18W
16W → 36W



MODEL 型號	FT 呎	CT 色溫	LUMENS 流明	BEAM ANGLE 發光角度	LAMP BASE 燈腳	CRI 顯色度	PACKING 包裝
LT8MS-2C-8W	2ft	4000K 6500K	900lm- 300lm	>200°	G13	>80	30pcs/ctn.
LT8MS-2C-16W	4ft	4000K 6500K	1800lm- 600lm				

Product Standard 產品標準

IEC 62776 IEC 62031 IEC/TR 62778

Microwave Induction Scheme

微波感應示意圖

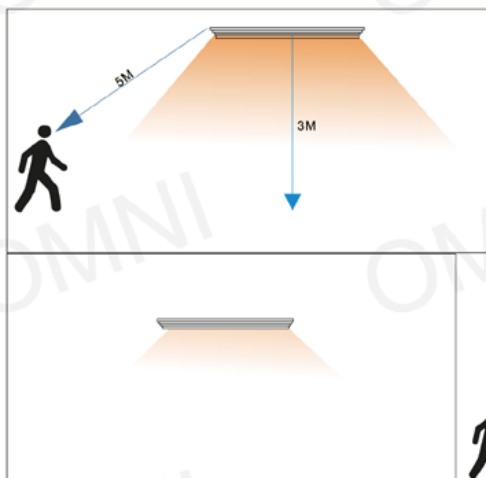

8W

Normal status
正常狀態 900lm



2.5W

Microwave status
微波狀態 300lm

*數值僅供參考

When no motion is sensed,
LT8MS tube will maintain 30% brightness after 30-40 seconds
光管會在無任何動作感應30-40秒後保持30%光度

Dimension 產品尺寸

FT 呎	Dimension 尺寸 (mm)	
	A	B
2ft	588	29
4ft	1198	29

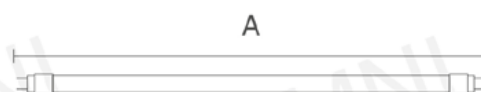

20,000
Hours



UP TO
85%
ENERGY
SAVINGS



LED T8 Tube LED T8 光管

Single Ended Input Tube
單端輸入光管

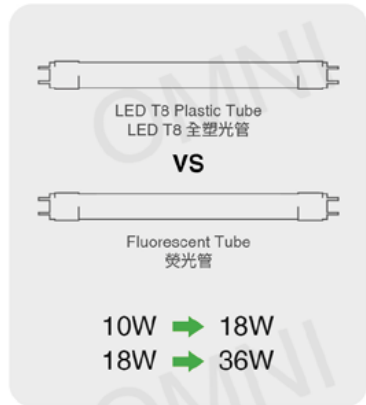

MODEL 型號	FT 呎	CT 色溫	LUMENS 流明	BEAM ANGLE 發光角度	LAMP BASE 燈腳	CRI 顯色度	PACKING 包裝
LT8S-10W	2ft	3000K 4000K 6500K	900lm				
LT8S-18W	4ft	3000K 4000K 6500K	1800lm	>200°	G13	>80	30pcs/ctn.
LT8S-23W*	5ft	3000K 4000K 6500K	2200lm				

*Indent order 需預訂

Dimension 產品尺寸

FT 呎	Dimension 尺寸 (mm)	
	A	B
2ft	588	28
4ft	1198	28
5ft	1498	28

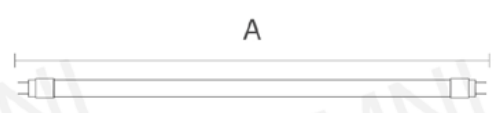

Accessories 配件



LT8-FUSE



LT8-LH

LED T5 Tube LED T5 光管

LED T5 Glass Tube Direct to Mains
LED T5 玻璃光管 AC220V

LED T5 Glass Tube Direct to Mains
LED T5 玻璃光管 直氣220V

VS

Fluorescent Tube
螢光管

8W → 14W
16W → 28W
22W → 35W



MODEL 型號	FT 呎	CT 色溫	LUMENS 流明	BEAM ANGLE 發光角度	LAMP BASE 燈腳	CRI 顯色度	PACKING 包裝
LT5-8W	2ft	3000K 4000K 6500K	900lm				
LT5-16W	4ft	3000K 4000K 6500K	2000lm	200°	G5	>80	30pcs/ctn.
LT5-22W	5ft	3000K 4000K 6500K	2600lm				

Installation Diagram 安裝示意圖

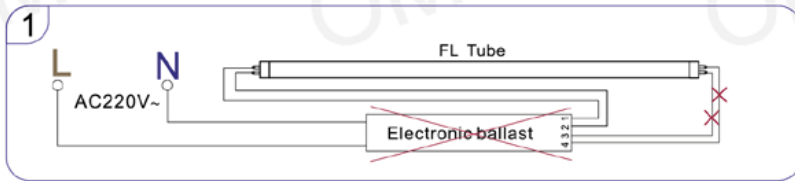

Cut off the power supply, then cut off the electronic ballast
切斷電源，剪取電子鎮流器

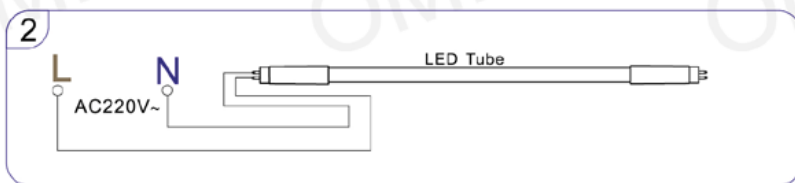

Product Standard 產品標準

- EN 55015
- EN 61547
- EN 61000-3-2
- EN 61000-3-3
- EN 60598-2-1
- EN 60598-1
- EN 62471
- EN 61347-2-13
- EN 61347-1
- EN 62493
- IEC 62778

Dimension 產品尺寸

FT 呎	Dimension 尺寸 (mm)	
	A	B
2ft	549	18.5
4ft	1149	18.5
5ft	1449	18.5

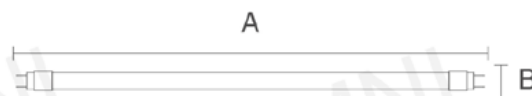

LED T5 Tube LED T5 光管

LED T5 Glass Tube Ballast Compatibility*
LED T5 兼容電子鎮流器玻璃光管*

LED T5 Glass Tube Ballast Compatibility
LED T5 兼容電子鎮流器玻璃光管

VS

Fluorescent Tube
螢光管

8W → 14W
15W → 28W
22W → 35W



MODEL 型號	FT 呎	CT 色溫	LUMENS 流明	BEAM ANGLE 發光角度	LAMP BASE 燈腳	CRI 顯色度	PACKING 包裝
LT5B-8W	2ft	3000K 4000K 6500K	900lm				
LT5B-15W	4ft	3000K 4000K 6500K	2000lm	200°	G5	>80	30pcs/ctr.
LT5B-22W	5ft	3000K 4000K 6500K	2600lm				

Installation Diagram 安裝示意圖

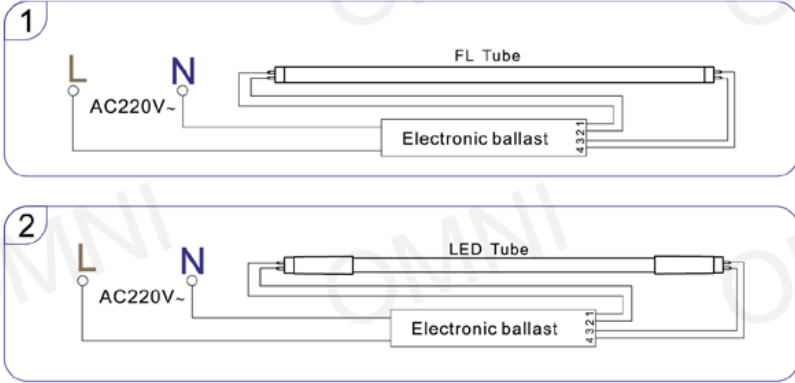

Product Standard 產品標準

- IEC 62031
- EN 62031
- IEC 62471
- IEC/TR 62778
- IEC 62776
- EN 62776

Dimension 產品尺寸

FT 呎	Dimension 尺寸 (mm)	
	A	B
2ft	549	18.5
4ft	1149	18.5
5ft	1449	18.5

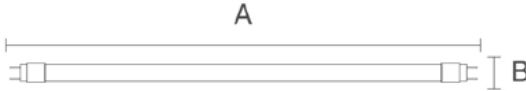

*Only applicable to specified electronic ballast
適用於指定電子鎮流器

LED MR16 Spotlight

LED MR16 射燈



LED MR16
Spotlight
LED MR16 射燈

vs



Halogen
Spotlight
石英射燈

5W → 35W
8W → 50W
10W → 75W

- 90% energy savings when compared to halogen bulb
比石英膽節能高達90%
- UV, IR and Mercury free
不含紫外線、紅外線及水銀
- Less heat emission
熱能釋放量低
- 20,000 hours of average lifetime
平均壽命可達20,000小時
- 24°, 38°, 60°, 100° beam angle available
24°、38°、60°及100°發光角度可供選擇



LED MR16 Spotlight 5W

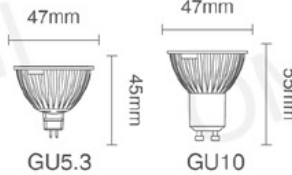

適用於



5W 24°/38°



5W 100°

MODEL 型號	CT 色溫	LUMENS 流明	BEAM ANGLE 發光角度	LAMP BASE 燈腳	CRI 顯色度	PACKING 包裝
LFGU10/GU5.3-5W-4K-24	4000K	400lm	24°	GU10/ GU5.3	>80	48pcs/ctn.
LFGU10/GU5.3-5W-3K-24	3000K	380lm				
LFGU10/GU5.3-5W-2K-24	2700K	380lm				
LFGU10/GU5.3-5W-6K-38	6500K	420lm	38°			
LFGU10/GU5.3-5W-4K-38	4000K	400lm				
LFGU10/GU5.3-5W-3K-38	3000K	380lm				
LFGU10/GU5.3-5W-2K-38	2700K	380lm	100°			
LFGU10/GU5.3-5W-4K-100	4000K	400lm				
LFGU10/GU5.3-5W-3K-100	3000K	380lm				
LFGU10/GU5.3-5W-2K-100	2700K	380lm				

LED MR16 Spotlight

LED MR16 射燈

vs

LED MR16 Spotlight
LED MR16 射燈

Halogen Spotlight
石英射燈

5W → 35W
8W → 50W
10W → 75W



LED MR16 Spotlight 8W

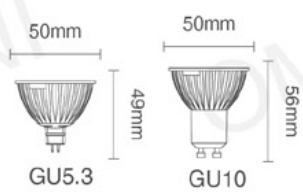

適用於  



MODEL 型號	CT 色溫	LUMENS 流明	BEAM ANGLE 發光角度	LAMP BASE 燈腳	CRI 顯色度	PACKING 包裝
LFGU10/GU5.3-8W-6K-38	6500K	650lm	38°	GU10/ GU5.3	>80	48pcs/ctn.
LFGU10/GU5.3-8W-4K-38	4000K	630lm				
LFGU10/GU5.3-8W-3K-38	3000K	600lm				
LFGU10/GU5.3-8W-2K-38	2700K	600lm	100°			
LFGU10/GU5.3-8W-4K-100	4000K	630lm				
LFGU10/GU5.3-8W-3K-100	3000K	600lm				
LFGU10/GU5.3-8W-2K-100	2700K	600lm				

LED MR16 Spotlight

LED MR16 射燈

	vs		5W → 35W
LED MR16 Spotlight LED MR16 射燈		Halogen Spotlight 石英射燈	8W → 50W
			10W → 75W

LED Industrial and Commercial Lighting Series
LED 工商業照明系列

LED MR16 Spotlight 10W

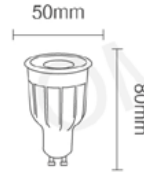

MODEL 型號	CT 色溫	LUMENS 流明	BEAM ANGLE 發光角度	LAMP BASE 燈腳	CRI 顯色度	PACKING 包裝
LFGU10-10W-6K	6500K	800lm	60°	GU10	>80	48pcs/ctn.
LFGU10-10W-4K	4000K	780lm				
LFGU10-10W-3K	3000K	750lm				

IEC
62838

IEC
62031

EN
61547

EN
55015

EN
62493



20,000
Hours



UP TO
90%
ENERGY
SAVINGS



Accessories 配件

LED Driver 驅動器

IEC
61347

AC/
DC12V

1W-
10W



MODEL 型號	INPUT 輸入	OUTPUT 輸出	Tc 表面溫度	Ta 環境溫度	PACKING 包裝
LDD-030	AC220-240V~50/60Hz	12V=1A 1-10W	80°C	45°C	40pcs/ctn.

Housing 支架



GU10-05



20,000
Hours



UP TO
90%
ENERGY
SAVINGS



LED MR16 Dimmable Spotlight

LED MR16 調光射燈

LED MR16 Dimmable Spotlight vs Halogen Spotlight

COB 6.5W → 50W
8W → 50W

- 10°, 12°, 24°, 36° beam angle available
10°、12°、24°及36°發光角度可供選擇
- Superior COB chip
名廠COB芯片
- High color rendering index CRI 90
高顯色CRI 90
- CRI 95 is available for order
可訂制CRI 95
- Compatible with different dimming methods
可匹配不同調光方式



LED MR16 Dimmable Spotlight 6.5W



適用於



MODEL 型號	CT 色溫	LUMENS 流明	BEAM ANGLE 發光角度	LAMP BASE 燈腳	CRI 顯色度	PACKING 包裝
LFGU5.3D-6.5W	6500K 4000K 3000K 2700K	600lm	10°/12°/24°/36°	GU5.3	>90	24pcs/ctn.
LFGU10D-6.5W	6500K 4000K 3000K 2700K	600lm	10°/12°/24°/36°	GU10	>90	24pcs/ctn.

*COB芯片

LED MR16 Dimmable Spotlight 8W

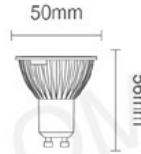

MODEL 型號	CT 色溫	LUMENS 流明	BEAM ANGLE 發光角度	LAMP BASE 燈腳	CRI 顯色度	PACKING 包裝
LFGU10D-8W-WW	2700K 3000K	600lm	38°	GU10	>80	48pcs/ctn.

LED Panel Light

LED 平板燈

MODEL 型號	WATT 瓦數	CT 色溫	LUMENS 流明	CRI 顯色度	PACKING 包裝
LBP660-36W-CCT	36W	3000K/ 4000K /5700K	3600lm	80	4pcs/ctn.
LBP612-60W-CCT	60W	3000K/ 4000K/ 5700K	6000lm		

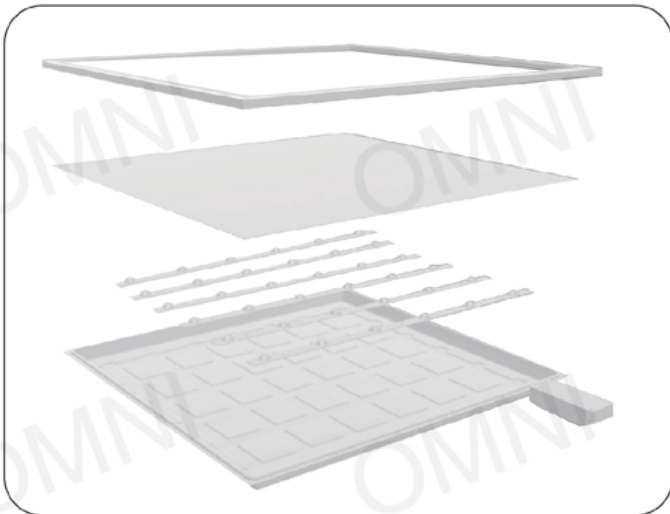

- 一燈三色溫 3000K/ 4000K/ 5700K
One Panel Three Color Temperatures
- 頻閃指標 <math><0.4\text{ SVM}</math>
- 色溫可調 CCT Switch Changeable
- 無黃斑 No Yellowish
- 功率因數 >0.9 PF >0.9



Dimension 產品尺寸

WATT 瓦數	Dimension 尺寸 (mm)		
	A	B	C
36W	595	595	32
60W	1195	595	32

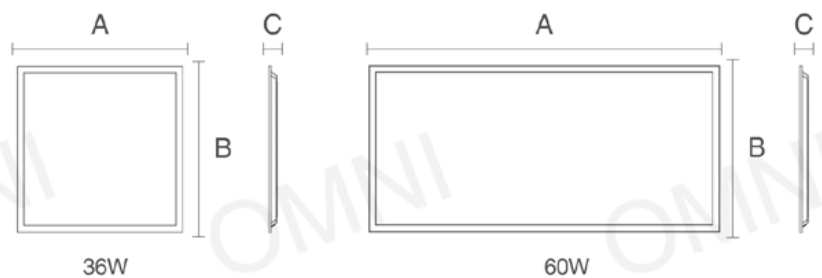

LED Panel Light LED 平板燈

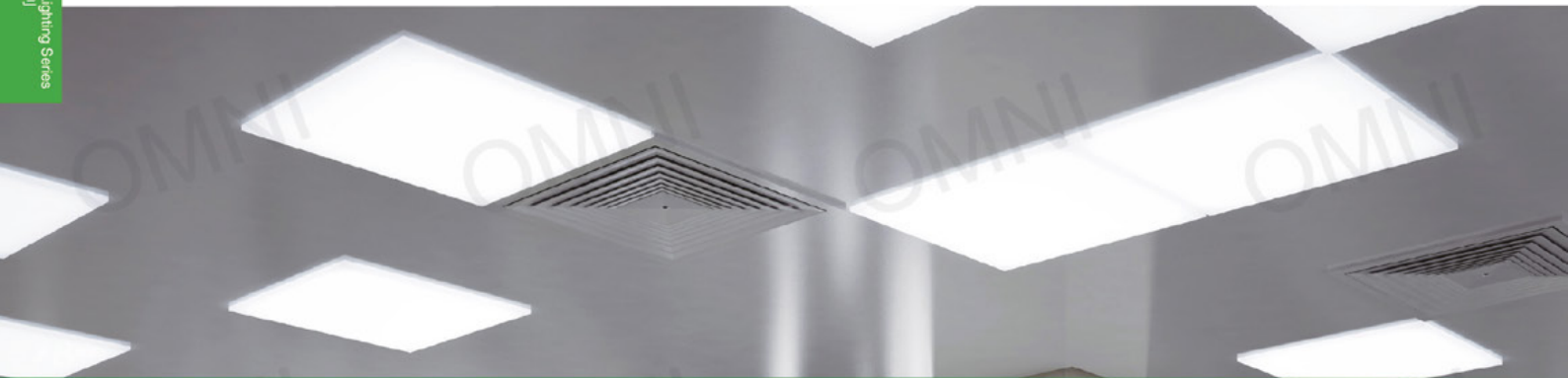

- Back-lit design, no yellowish 背光設計·無黃斑
- Metal frame and back plate 全金屬框架
- Isolated driver 隔離電源
- Dimmable available 可選配調光版本 ☉
- 25,000 hours of average lifetime 平均壽命可達25,000小時

Accessories 配件

Surface Mounting Frame 吸頂框



SMF-660 / SMF-312 / SMF-612

Suspended Mounting Kit 懸掛安裝套裝



SMK-1845



Dimmable

Dimmable Version
調光版本

=



LED Dimmer 調光開關

+



LED Dimmable Driver 調光火牛

LED Linear Light

LED 線條燈



MODEL 型號	WATT 瓦數	CT 色溫	LUMENS 流明	PF 功率因數	CRI 顯色度	PACKING 包裝
LSH-20W	20W	3000K/ 4000K/ 6500K	1900lm	>0.9	>82	1pc/ctn.
LSH-30W	30W	3000K/ 4000K/ 6500K	2850lm			
LSH-40W	40W	3000K/ 4000K/ 6500K	3800lm			
LSH-50W	50W	3000K/ 4000K/ 6500K	4750lm			
LSH-60W	60W	3000K/ 4000K/ 6500K	5700lm			

Photometric 光學度

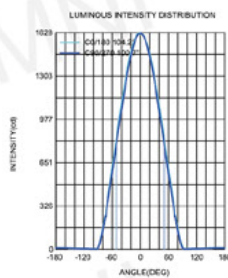
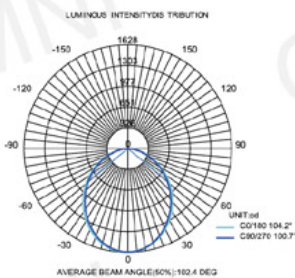

Installation 安裝

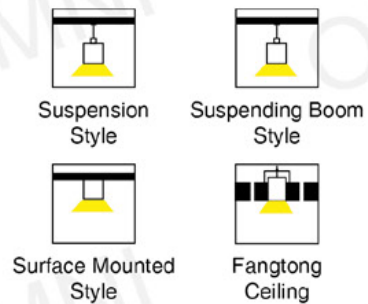

Dimension 產品尺寸

WATT 瓦數	Dimension 尺寸 (mm)		
	A	B	C
20W	600	90	72
30W	900	90	72
40W	1200	90	72
50W	1500	90	72
60W	1800	90	72



LED Adjustable Downlight LED 可調角度筒燈

LED Adjustable Downlight (LLRC)



MODEL 型號	CT 色溫	LUMENS 流明	BEAM ANGLE 發光角度	RADIATION ANGLE 照射角度	CRI 顯色度	PACKING 包裝
LLRC-38RM-8WDL	6500K	640lm	38°	30°+30°=60°	>80	10pcs/ctn.
LLRC-38RM-8WCW	4000K	610lm				
LLRC-38RM-8WW	3000K	580lm				

*Dimmable version is available for order 可預訂調光版本

Radiation Angle 照射角度

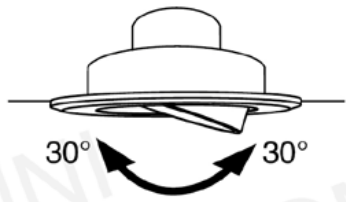

Dimension 產品尺寸

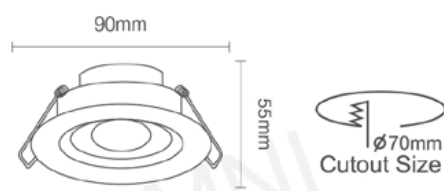

- IEC 62031
- IEC 62471
- IEC 62560
- CE
- 20,000 Hours
- 38° WIDE ANGLE
- 220V-240V~50/60Hz
- UP TO 85% ENERGY SAVINGS
- NO UV/IR
- SAFE EASY TO USE
- RoHS compliant
- Recycling symbol

LED Adjustable Downlight (LR) 三年保用



3 year warranty

Model: LR- - - -

Φ55	3W	15°	2700K
Φ75	5W	24°	3000K
	7W	36°	4000K
	9W		
	12W		

Radiation Angle 照射角度



Dimension 產品尺寸

WATT 瓦數	CUTOUT SIZE 開孔尺寸	Dimension 尺寸 (mm)		
		A	B	C
3W	Φ55	63	36	34
5W	Φ55	63	36	34
5W	Φ75	88	47	45
7W	Φ75	88	47	45
9W	Φ75	88	47	45
12W	Φ75	88	47	45

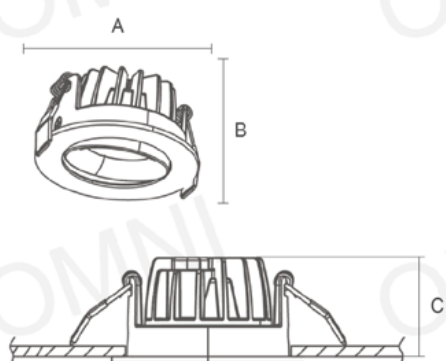

- CE
- CRI 90
- >0.9 Power Factor
- 1-26 mm
- 230V
- Dimmable
- RoHS Compliant

LED Ultra Slim Downlight

LED 超薄身筒燈

- Ultra Slim design with external driver, suitable for low ceiling
超薄燈體設計，搭配上外置式驅動器，特別適用於矮樓底
- Matte white case fits all types of ceiling design
啞白色外殼易於融入各式各樣天花設計
- 20,000 hours of average lifetime
平均壽命可達20,000小時



LED Ultra Slim Downlight 9W

MODEL 型號	CT 色溫	LUMENS 流明	INCHES 吋	CRI 顯色度	PACKING 包裝
LRC5-9WDL	6000K	800lm	5"	>80	20pcs/ctn.
LRC5-9WCW	4000K	800lm			
LRC5-9WW	3000K	700lm			



LED Ultra Slim Downlight 12W

MODEL 型號	CT 色溫	LUMENS 流明	INCHES 吋	CRI 顯色度	PACKING 包裝
LRC6-12WDL	6000K	1100lm	6"	>80	20pcs/ctn.
LRC6-12WCW	4000K	1100lm			
LRC6-12WW	3000K	1000lm			



LED Ultra Slim Downlight 16W

MODEL 型號	CT 色溫	LUMENS 流明	INCHES 吋	CRI 顯色度	PACKING 包裝
LRC7-16WDL	6000K	1400lm	7"	>80	10pcs/ctn.
LRC7-16WCW	4000K	1400lm			
LRC7-16WW	3000K	1300lm			

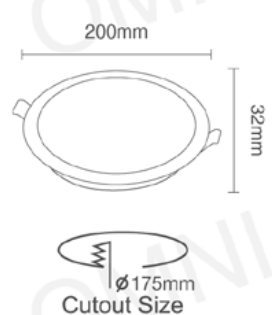

LED Ultra Slim Downlight 18W

MODEL 型號	CT 色溫	LUMENS 流明	INCHES 吋	CRI 顯色度	PACKING 包裝
LRC8-18WDL	6000K	1700lm	8"	>80	10pcs/ctn.
LRC8-18WCW	4000K	1700lm			
LRC8-18WW	3000K	1600lm			

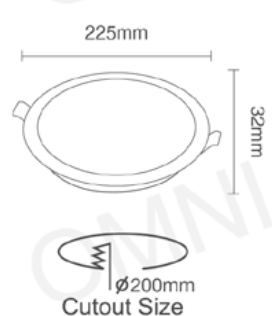

*External Driver is included 產品已配備外置驅動器
*Dimmable version is available for order 可預訂調光版本

LED Integrated Recessed Downlight LED 一體化嵌入式筒燈

LED Deluxe Recessed Downlight 豪華嵌入式筒燈

MODEL 型號	WATT 瓦數	CT 色溫	LUMENS 流明	BEAM ANGLE 發光角度	INCHES 吋	CUTOUT SIZE 開孔尺寸	CRI 顯色度	PACKING 包裝
LCDM-4-12W	12W		1050lm		4"	100mm		1pc/ctn.
LCDM-6-20W	20W	2700K/ 3000K/	1850lm	40°/60°	6"	150mm	>80	
LCDM-6-30W	30W	4000K/ 5000K	2450lm		6"	150mm		
LCDM-8-40W	40W		3450lm		8"	200mm		



- Nichia LED COB Chip
- Lifud Driver
- 90V-265V

Dimension 產品尺寸

WATT 瓦數	Dimension 尺寸 (mm)	
	A	B
12W	140	95
20W	190	110
30W	190	110
40W	240	110

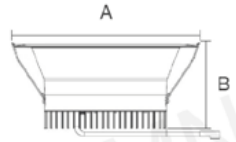

LED Supreme Recessed Downlight 至尊嵌入式筒燈

MODEL 型號	WATT 瓦數	CT 色溫	LUMENS 流明	BEAM ANGLE 發光角度	INCHES 吋	CUTOUT SIZE 開孔尺寸	CRI 顯色度	PACKING 包裝
LHID-6-60W	60W		5800lm		6"	100mm		1pc/ctn.
LHID-8-60W	60W	3000K/ 4000K/	5800lm	60°	8"	200mm	>80	
LHID-10-100W	100W	5000K/ 5800K	9500lm		10"	250mm		
LHID-12-100W	100W		9500lm		12"	300mm		



- Citizen COB Chip
- Meanwell Driver
- 90V-265V

Dimension 產品尺寸

WATT 瓦數	Dimension 尺寸 (mm)	
	A	B
6" 60W	169	163
8" 60W	220	165
10" 100W	270	197
12" 100W	340	197

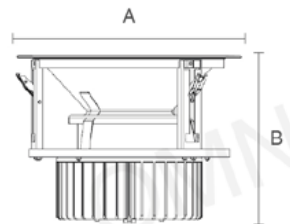

LED High Power Bulb

LED 高效能柱燈



LED High Power Bulb 50W

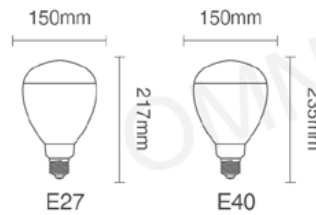

MODEL 型號	WATT 瓦數	CT 色溫	LUMENS 流明	LAMP BASE 燈腳	AVE. LIFE 平均壽命	PACKING 包裝
LHP150E27-50WDL	50W	6500K	4500lm	E27	20,000hrs	6pcs/ctn.
LHP150E27-50WCW	50W	4000K	4400lm			
LHP150E40-50WDL	50W	6500K	4500lm	E40		
LHP150E40-50WCW	50W	4000K	4400lm			

LED High Power Bulb 75W

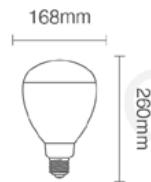

MODEL 型號	WATT 瓦數	CT 色溫	LUMENS 流明	LAMP BASE 燈腳	AVE. LIFE 平均壽命	PACKING 包裝
LHP170E40-75WDL	75W	6500K	6500lm	E40	20,000hrs	6pcs/ctn.
LHP170E40-75WCW	75W	4000K	6200lm			

Accessories 配件



=



Heavy Duty Lamp Holder
重力燈支架

Model 型號:
E40-608 / E40-608H /
E27-608 / E27-608H

+



Aluminum Cap
鋁質頂蓋

Model 型號:
HAC-16"

+



Acrylic Dome Diffuser
亞加力燈罩

Model 型號:
DPR-16" / DPR-22"



CRI
>80



LED Heavy Duty Globe LED 高效能柱燈

- AL1070 aluminum housing by cold-forging technology with better heat-sink
AL1070鋁外殼採用冷鍛技術製造，散熱性能更佳
- SMD2835 LEDs with high efficiency 100lm/w
SMD2835 LEDs提供更高發光效率，達100lm/w
- 1KV surge protection and 4000V hi-pot tested and approved
1KV 電湧保護及通過4000V耐壓測試
- Compact size used for HID retrofit
體積比氬氣燈小巧
- 25,000 hours of average lifetime
平均壽命可達25,000小時



LED High Power Bulb 5700K

MODEL 型號	WATT 瓦數	CT 色溫	LUMENS 流明	BEAM ANGLE 發光角度	LAMP BASE 燈腳	AVE. LIFE 平均壽命	PACKING 包裝
LVZ-100W-E40-57K	100W	5700K	10000lm	180°	E40	25,000hrs	6pcs/ctn.
LVZ-120W-E40-57K	120W	5700K	12000lm				
LVZ-150W-E40-57K	150W	5700K	15000lm				

*CT: 3000K/ 4000K/ 5700K/ 6500K is available for order 可選不同色溫

Dimension 產品尺寸

WATT 瓦數	Dimension 尺寸 (mm)	
	A	B
100W	140	278
120W	140	297
150W	167	324

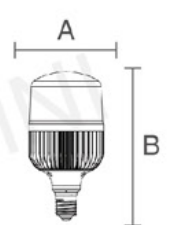

Suggested Installation Height 安裝建議高度

Watt	Height
100W	5-7m
150W	8-10m

Replacement is Based on Lux 燈膽替換Lux參考值

LED	CFL	HID
100W =	150W	175W
150W =	240W	320W

LED High Bay Lamp

LED 高樓底燈



vs



100W → 230W
150W → 380W
200W → 500W

-Integrated high bay lamp for easy installation and maintenance

一體化設計高樓底燈照明,方便安裝及保養

-A variety of accessories are available, which fit for various environment

備有多種配件可供選購,適合不同環境需要

-Warranty period up to 5 year

保養期最高可長達5年

LED Multiplicity High Bay Lamp 多樣式高樓底燈

MODEL 型號	WATT 瓦數	CT 色溫	LUMENS 流明	BEAM ANGLE 發光角度	CRI 顯色度	PACKING 包裝
LSHN-100W	100W	4000K / 5000K	13000lm	60°#/ 70°#/ 90°#/ 120°	>80	1pc/ctn.
LSHN-150W	150W	4000K / 5000K	19500lm			
LSHN-200W	200W	4000K / 5000K	26000lm			

*Tailor-made color temperature is available for order 可訂制不同色溫

*Dimmable version is available for order 可預訂調光版本

#Apply together with diffuser 需配合散光罩

Dimension 產品尺寸

WATT 瓦數	Dimension 尺寸 (mm)	
	A	B
100W	252	180
150W	252	180
200W	280	228

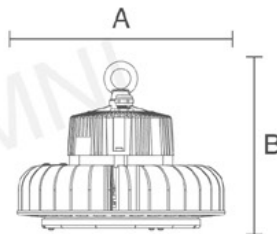

Accessories 配件

Multiplicity High Bay Sensor
多樣式高樓底燈感應器



Model 型號: LSHN-S

Multiplicity High Bay Mounted Holder
多樣式高樓底燈天花支架



Model 型號: LSHN-C

Multiplicity High Bay Adjustable Angle Holder
多樣式高樓底燈調角度支架



Model 型號: LSHN-A

Multiplicity High Bay Plastic Diffuser
多樣式高樓底燈膠散光罩

Multiplicity High Bay Aluminum Diffuser
多樣式高樓底燈鋁散光罩

Diffuser 散光罩 P.30

LED High Bay Lamp

LED 高樓底燈

LED High Bay Skye
LED Skye 高樓底燈

vs

High Pressure Mercury Lamp
高壓水銀燈

100W → 230W
150W → 380W
200W → 500W



- Patent housing design with TGIC paint material which is suitable for tough application as well as lighter, slimmer and smaller in size
專利外殼設計，更輕巧、纖薄；採用TGIC塗料，適用於惡劣環境

- A variety of accessories are available, which fit for various environment
備有多種配件可供選購，適合不同環境需要

- CREE SMD2835 LEDs and built-in quality/stable driver provide high efficiency which up to 150lm/w and 96%

CREE SMD2835 LEDs提供更高發光效率，高達150lm/w；內置質量/穩定驅動器，更可提供高達96%的高效率

- Isolated 3-in-1 dimming option, 1-10v, PMW, resistance
可選配三合一調光，1-10v，PMW，resistance

- 5-year warranty
保養期長達5年

LED High Bay Skye

MODEL 型號	WATT 瓦數	CT 色溫	LUMENS 流明	WEIGHT 重量	BEAM ANGLE 發光角度	CRI 顯色度	PACKING 包裝
LSKD-100W	100W	3000K/ 4000K/ 5700K	15000lm	1.89kg	60°#/ 70°#/ 90°#/ 120°	80	1pc/ctn.
LSKD-150W	150W	3000K/ 4000K/ 5700K	22500lm	2.65kg			
LSKD-200W	200W	3000K/ 4000K/ 5700K	30000lm	2.65kg			

*Tailor-made color temperature is available for order 可訂制不同色溫

*Dimmable version is available for order 可訂調光版本

*Sensor version is available for order 可訂制感應版本

#Apply together with diffuser 需配合散光罩

Dimension 產品尺寸

WATT 瓦數	Dimension 尺寸 (mm)	
	A	B
100W	226	152
150W	275	152
200W	275	152

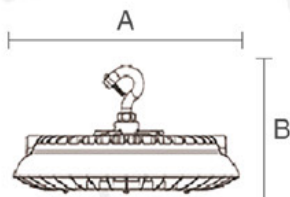

LM80

TM21

IES
available

4KV
surge
protection



50,000
Hours

IP65



150
lm/w

5-YEAR
WARRANTY

Isolated
driver



TGIC
painting

DIY
lens



RoHS
Compliant



LED High Bay Lamp

LED 高樓底燈



LED High Bay Skye
LED Skye 高樓底燈

vs



High Pressure
Mercury Lamp
高壓水銀燈

100W → 230W
150W → 380W
200W → 500W

Accessories 配件

PC Lens 60° / 90°



Model 型號:
LENS-60D / LENS-90D

Drop Leds



Wire Guard



Sensor



Installation 安裝



Hook Mount

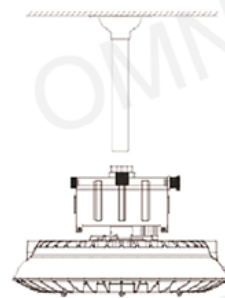

Pole Mount

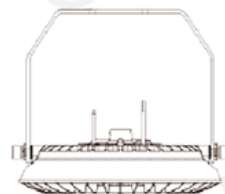

Surface Mount

Aluminum Reflector



Model 型號:
AL-60D / AL-90D

Beam Angle 發光角度:
60° / 90°

Shield for Aluminum Cover



PC Reflector



Model 型號:
PC-70D

Beam Angle 發光角度:
70°

Shield for PC Cover



Surface-mounted Installation



Meanwell DALI Control Adaptor



Extended Wires



Waterproof Connector



Stainless Steel Chains



Max. hanging weight: 15kg
Length: 1m

Stainless Steel Buckle



Max. hanging weight: 20kg

Plug



CREE SMD2835

LM80

TM21

IES available

4KV surge protection

CE

50,000 Hours

IP65

200° Beam Angle

150 lm/w

5-YEAR WARRANTY

Isolated driver

90-305VAC

TGIC painting

DIY lens

NO UV/IR

SAFE EASY TO USE

RoHS Compliant



LED PAR Lamp LED 防水PAR燈

LED PAR Lamp vs Incandescent PAR Lamp

6W → 50W
10W → 80W
15W → 120W

LED PAR 20 6W **IP65**



MODEL 型號	CT 色溫	LUMENS 流明	BEAM ANGLE 發光角度	LAMP BASE 燈腳	AVE. LIFE 平均壽命	PACKING 包裝
LPR20E27-6W/D	6500K	400lm	30°	E27	20,000hrs	48pcs/ctn.
LPR20E27-6W/W	3000K	380lm				

LED PAR 30 10W **IP65**



MODEL 型號	CT 色溫	LUMENS 流明	BEAM ANGLE 發光角度	LAMP BASE 燈腳	AVE. LIFE 平均壽命	PACKING 包裝
LPR30E27-10W/D	6500K	700lm	30°	E27	20,000hrs	24pcs/ctn.
LPR30E27-10W/W	3000K	750lm				

LED PAR 38 15W **IP65**



MODEL 型號	CT 色溫	LUMENS 流明	BEAM ANGLE 發光角度	LAMP BASE 燈腳	AVE. LIFE 平均壽命	PACKING 包裝
LPR38E27-15W/D	6500K	1100lm	30°	E27	20,000hrs	12pcs/ctn.
LPR38E27-15W/W	2700K	1000lm				

Dimmable Version 可調光版本



LED Dimmable PAR 30 10W **IP54**



MODEL 型號	CT 色溫	LUMENS 流明	BEAM ANGLE 發光角度	LAMP BASE 燈腳	AVE. LIFE 平均壽命	PACKING 包裝
LPR30E27D-10W	3000K/	850lm	30°/ 60°	E27	20,000hrs	12pcs/ctn.
	4000K/	900lm				
	6000K	900lm				

LED Dimmable PAR 38 15W **IP54**



MODEL 型號	CT 色溫	LUMENS 流明	BEAM ANGLE 發光角度	LAMP BASE 燈腳	AVE. LIFE 平均壽命	PACKING 包裝
LPR38E27D-15W	3000K/	1200lm	30°/ 60°	E27	20,000hrs	12pcs/ctn.
	4000K/	1250lm				
	6000K	1250lm				

IP65 LED Bulb

LED 防水燈膽



-IP65 weatherproof
IP65 防水級別

-Adapted to enclosed fixture with a diameter of $\geq 300\text{mm}$
適用於 $\geq 300\text{mm}$ 直徑的密封燈具

-Applicable to garden, park, playground, roadway, etc.
適用於庭園、公園、遊樂場、馬路或公路

IP65 LED Bulb 20W

MODEL 型號	CT 色溫	LUMENS 流明	LAMP BASE 燈腳	CRI 顯色度	PACKING 包裝
LHM73E27-20W	2300K/ 2700K/ 3000K/ 4000K/ 5000K	3000lm	E27	>75	10pcs/ctn.

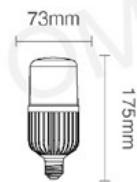

IP65 LED Bulb 30W

MODEL 型號	CT 色溫	LUMENS 流明	LAMP BASE 燈腳	CRI 顯色度	PACKING 包裝
LHM73E27-30W	2300K/ 2700K/ 3000K/ 4000K/ 5000K	4500lm	E27	>75	10pcs/ctn.

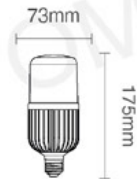

IP65 LED Bulb 40W

MODEL 型號	CT 色溫	LUMENS 流明	LAMP BASE 燈腳	CRI 顯色度	PACKING 包裝
LHM73E27-40W	2300K/ 2700K/ 3000K/ 4000K/ 5000K	6300lm	E27	>75	10pcs/ctn.
LHM73E40-40W	2300K/ 2700K/ 3000K/ 4000K/ 5000K	6300lm	E40	>75	10pcs/ctn.

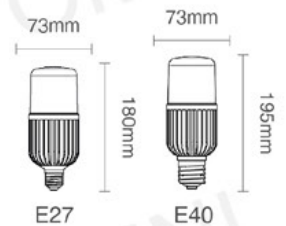

Photometric 光學度

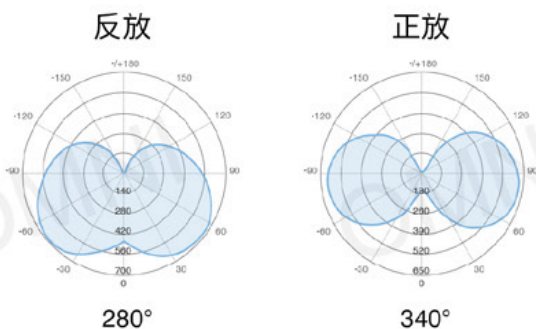

- 燈泡寬度73mm，適用於 $\geq 300\text{mm}$ 直徑的密封燈具
- LHM系列20W-40W代替傳統son膽光源50W-150W (參考值)

LED Weatherproof Light LED 防水面包燈



LED Circular Weatherproof Light 圓形防水燈

LED Circular Weatherproof Light 8W

MODEL 型號	CT 色溫	LUMENS 流明	AVE. LIFE 平均壽命	CRI 顯色度	PACKING 包裝
LWCL-8WDL	6500K	650lm	20,000hrs	>80	10pcs/ctn.
LWCL-8WCW	4000K	630lm			
LWCL-8WW	2700K	600lm			

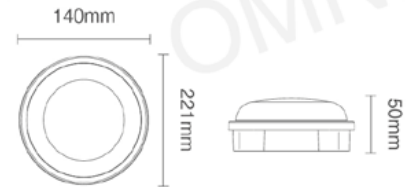

LED Circular Weatherproof Light 12W

MODEL 型號	CT 色溫	LUMENS 流明	AVE. LIFE 平均壽命	CRI 顯色度	PACKING 包裝
LWCL-12WDL	6500K	1000lm	20,000hrs	>80	10pcs/ctn.
LWCL-12WCW	4000K	980lm			
LWCL-12WW	2700K	950lm			

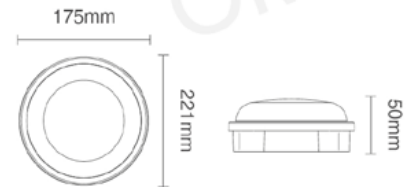

LED Circular Weatherproof Light 20W

MODEL 型號	CT 色溫	LUMENS 流明	AVE. LIFE 平均壽命	CRI 顯色度	PACKING 包裝
LWCL-20WDL	6500K	1800lm	20,000hrs	>80	10pcs/ctn.
LWCL-20WCW	4000K	1700lm			
LWCL-20WW	2700K	1600lm			

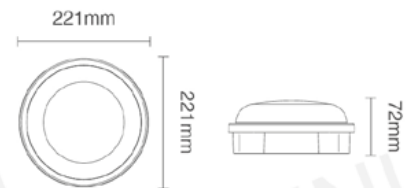

LED Circular Weatherproof Light 30W

MODEL 型號	CT 色溫	LUMENS 流明	AVE. LIFE 平均壽命	CRI 顯色度	PACKING 包裝
LWCL-30WDL	6500K	2500lm	20,000hrs	>80	10pcs/ctn.
LWCL-30WCW	4000K	2450lm			
LWCL-30WW	2700K	2400lm			

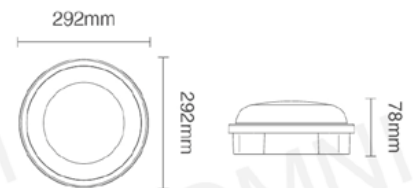

LED Square Weatherproof Light 正方形防水燈

LED Square Weatherproof Light 20W



MODEL 型號	CT 色溫	LUMENS 流明	AVE. LIFE 平均壽命	CRI 顯色度	PACKING 包裝
LWQL-20WDL	6500K	1600lm	20,000hrs	>80	10pcs/ctn.
LWQL-20WW	2700K	1500lm			

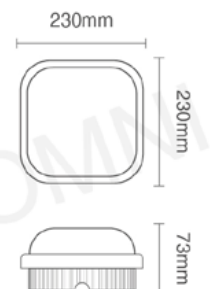

LED Weatherproof Light LED 防水面包燈



LED Rectangular Weatherproof Light 長方形防水燈

LED Rectangular Weatherproof Light 15W

MODEL 型號	CT 色溫	LUMENS 流明	AVE. LIFE 平均壽命	CRI 顯色度	PACKING 包裝
LWSL-15WDL	6500K	1200lm	20,000hrs	>80	10pcs/ctn.
LWSL-15WW	2700K	1100lm			

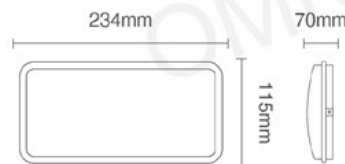

LED Rectangular Weatherproof Light 20W

MODEL 型號	CT 色溫	LUMENS 流明	AVE. LIFE 平均壽命	CRI 顯色度	PACKING 包裝
LWSL-20WDL	6500K	1600lm	20,000hrs	>80	10pcs/ctn.
LWSL-20WW	2700K	1500lm			

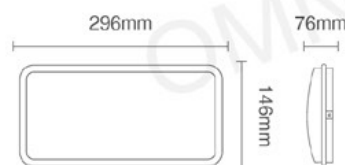

LED Microwave Sensor Weatherproof Light 微波感應防水燈

LED Microwave Sensor Weatherproof Light 20W



MODEL 型號	CT 色溫	LUMENS 流明	AVE. LIFE 平均壽命	CRI 顯色度	PACKING 包裝
LWSL-MS20WDL	6500K	1600lm	20,000hrs	>80	10pcs/ctn.
LWSL-MS20WW	2700K	1500lm			

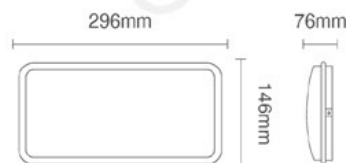

LED Oval Weatherproof Light 橢圓形防水燈

LED Oval Weatherproof Light 8W

MODEL 型號	CT 色溫	LUMENS 流明	AVE. LIFE 平均壽命	CRI 顯色度	PACKING 包裝
LWOL-8WDL	6500K	650lm	20,000hrs	>80	10pcs/ctn.
LWOL-8WCW	4000K	630lm			
LWOL-8WW	2700K	600lm			

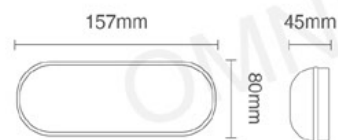

LED Oval Weatherproof Light 12W

MODEL 型號	CT 色溫	LUMENS 流明	AVE. LIFE 平均壽命	CRI 顯色度	PACKING 包裝
LWOL-12WDL	6500K	1000lm	20,000hrs	>80	10pcs/ctn.
LWOL-12WCW	4000K	980lm			
LWOL-12WW	2700K	950lm			

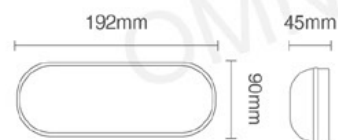

LED Micro Sensor Weatherproof Light

LED 微波感應防水面包燈

- Adjustable wattage 12/15/18/20W
可調校瓦數 12/15/18/20W
- 5.8G Microwave sensor
5.8G 微波感應器
- Can be equipped with emergency power supply
可配備應急電源使用
- IP 65 weatherproof
IP65 防水防塵
- Aluminum die casting base, PC cover
壓鑄鋁底座, PC罩

LED Micro Sensor Square Weatherproof Light

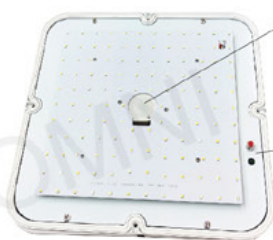

微波感應
Micro Sensor



應急
Emergency Power Supply

*1w = 100lm

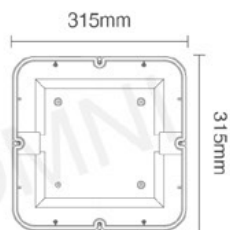

MODEL 型號	CT 色溫	PACKING 包裝
LBC-MS	3000K/ 4000K/ 6500K	1pc/ctn.

LED Micro Sensor Rectangular Weatherproof Light



*1w = 100lm

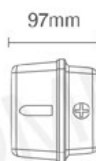

MODEL 型號	CT 色溫	PACKING 包裝
LBR-MS	3000K/ 4000K/ 6500K	1pc/ctn.

LED Weatherproof Fixture (Ultra Slim Linear Light)

LED 一體化纖巧三防支架

- Integrated slim and neat design with smooth finishing
一體化纖巧俐落設計，呈現出光滑外觀
- Uniform light output for greater area coverage
光源輸出一致，照射範圍覆蓋更佳
- With IP65 weatherproof, suitable for both indoor and outdoor applications
達IP65防水防塵級別，室內或室外應用佳宜
- Surface-mounted or suspended installation
掛牆或懸吊式安裝皆可



LED Weatherproof Fixture (Ultra Slim Linear Light) 18W

MODEL 型號	FT 呎	CT 色溫	LUMENS 流明	PF 功率因數	AVE. LIFE 平均壽命	CRI 顯色度	PACKING 包裝
LLW-18WDL	2ft	6500K	1600lm	>0.9	25,000hrs	72	20pcs/ctn.
LLW-18WCW		4000K	1500lm				

LED Weatherproof Fixture (Ultra Slim Linear Light) 36W

MODEL 型號	FT 呎	CT 色溫	LUMENS 流明	PF 功率因數	AVE. LIFE 平均壽命	CRI 顯色度	PACKING 包裝
LLW-36WDL	4ft	6500K	3200lm	>0.9	25,000hrs	72	20pcs/ctn.
LLW-36WCW		4000K	3100lm				
LLW-36WW		3000K	3000lm				

LED Weatherproof Fixture (Ultra Slim Linear Light) 45W

MODEL 型號	FT 呎	CT 色溫	LUMENS 流明	PF 功率因數	AVE. LIFE 平均壽命	CRI 顯色度	PACKING 包裝
LLW-45WDL	5ft	6500K	4000lm	>0.9	25,000hrs	72	20pcs/ctn.
LLW-45WCW		4000K	3800lm				

Dimension 產品尺寸

WATT 瓦數	Dimension 尺寸 (mm)		
	A	B	C
18W	662	66	38
36W	1262	66	38
45W	1500	60	35

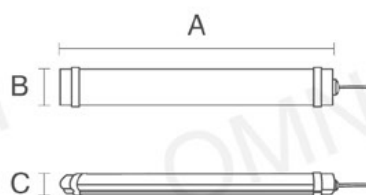

LED Weatherproof Flood Light

LED 耐用版防水泛光燈

LED Weatherproof Flood Light (LLFA)

MODEL 型號	WATT 瓦數	CT 色溫	LUMENS 流明	BEAM ANGLE 發光角度	CRI 顯色度	PACKING 包裝
LLFA-100W	100W	3000K/ 4000K/ 5000K	13000lm	Asymmetric	70	1pc/ctn.
LLFA-150W	150W	3000K/ 4000K/ 5000K	19500lm			
LLFA-200W	200W	3000K/ 4000K/ 5000K	26000lm			

Dimension 產品尺寸

WATT 瓦數	Dimension 尺寸 (mm)		
	A	B	C
100W	353	468	82
150W	353	468	82
200W	353	468	82

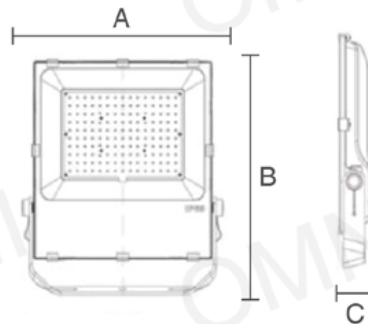

CE IP65 CB SAA

5-YEAR
WARRANTY

100V-277V~
50/60Hz

Dimmable

NO
UV/IR

SAFE
EASY TO USE

RoHS
Compliant



LED Weatherproof Flood Light (LLFP)

MODEL 型號	WATT 瓦數	CT 色溫	LUMENS 流明	BEAM ANGLE 發光角度	CRI 顯色度	PACKING 包裝
LLFP-50W	50W	3000K/ 4000K/ 5000K/ 5700K	6500lm	25°/ 50°/ 90°/ 120°/ 150°/ 70x140°/ 100x150°	70	1pc/ctn.
LLFP-100W	100W	3000K/ 4000K/ 5000K/ 5700K	13000lm			
LLFP-150W	150W	3000K/ 4000K/ 5000K/ 5700K	19500lm			
LLFP-200W	200W	3000K/ 4000K/ 5000K/ 5700K	26000lm			
LLFP-300W	300W	3000K/ 4000K/ 5000K/ 5700K	39000lm			

Dimension 產品尺寸

WATT 瓦數	Dimension 尺寸 (mm)		
	A	B	C
50W	184	346	54
100W	277	428	55
150W	278	483	60
200W	328	487	60
300W	378	576	65

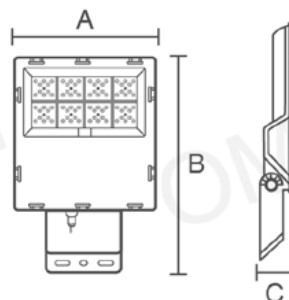

CE IP65 CB SAA

5-YEAR
WARRANTY

100V-277V~
50/60Hz

Dimmable

NO
UV/IR

SAFE
EASY TO USE

RoHS
Compliant



LED Jupiter Stadium Light

LED 室外運動場所照明燈



MODEL 型號	WATT 瓦數	4000K		5000K		BEAM ANGLE 發光角度	CRI 顯色度
		LUMENS 流明	LPW	LUMENS 流明	LPW		
LJP320W	320W	44080lm	138	46400lm	145	25° 45° 90°	Ra70/90
		45600lm	143	48000lm	150		
		45600lm	143	48000lm	150		
LJP480W	480W	66120lm	138	69600lm	145		
		68400lm	143	72000lm	150		
		68400lm	143	72000lm	150		
LJP600W	600W	80370lm	134	84600lm	141		
		82650lm	138	87000lm	145		
		82650lm	138	87000lm	145		
LJP1000W	1000W	122000lm	134	128000lm	141		
		125000lm	138	130000lm	145		
		125000lm	138	130000lm	145		

Dimension 產品尺寸

WATT 瓦數	Dimension 尺寸 (mm)	
	A	B
320W	422	400
480W	447	400
600W	462	400
1000W	568	400

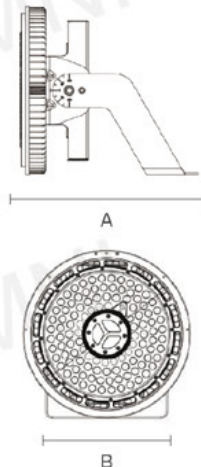

Accessories 配件



LED Street Light LED 街道燈



LED Street Light 60W

MODEL 型號	CT 色溫	LUMENS 流明	PF 功率因數	CRI 顯色度	PACKING 包裝
LRL-60WDL	6500K	6000lm	>0.9	70	1pc/ctn.
LRL-60WCW	4000K	6000lm			
LRL-60WW	2700K	5000lm			

LED Street Light 100W

MODEL 型號	CT 色溫	LUMENS 流明	PF 功率因數	CRI 顯色度	PACKING 包裝
LRL-100WDL	6500K	10000lm	>0.9	70	1pc/ctn.
LRL-100WCW	4000K	10000lm			
LRL-100WW	2700K	8500lm			

LED Street Light 150W

MODEL 型號	CT 色溫	LUMENS 流明	PF 功率因數	CRI 顯色度	PACKING 包裝
LRL-150WDL	6500K	15000lm	>0.9	70	1pc/ctn.
LRL-150WCW	4000K	15000lm			
LRL-150WW	2700K	12000lm			

LED Street Light 200W

MODEL 型號	CT 色溫	LUMENS 流明	PF 功率因數	CRI 顯色度	PACKING 包裝
LRL-200WDL	6500K	20000lm	>0.9	70	1pc/ctn.
LRL-200WCW	4000K	20000lm			
LRL-200WW	2700K	17000lm			

Installation Instructions 安裝說明

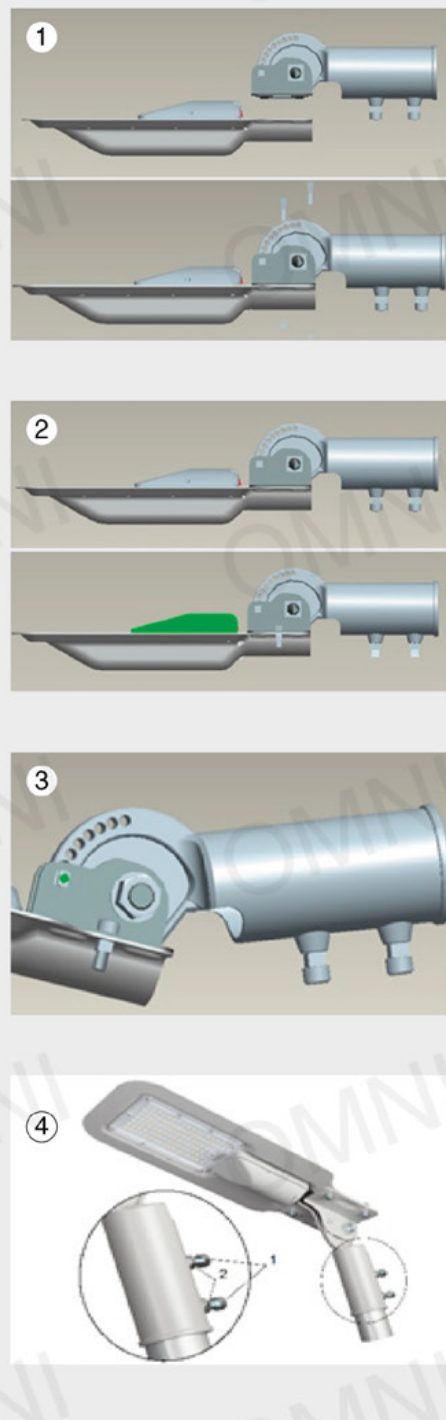

Dimension 產品尺寸

WATT 瓦數	Dimension 尺寸 (mm)	
	A	B
60W	385	161
100W	570	241
150W	687	242
200W	818	282

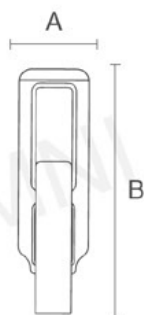

LED Area Light

LED 區域燈



MODEL 型號	WATT 瓦數	CT 色溫	LUMENS 流明	CRI 顯色度	PACKING 包裝
LMFL-100W	100W	4000K/ 5000K	14500lm	70	1pc/ctn.
LMFL-150W	150W	4000K/ 5000K	21750lm		
LMFL-200W	200W	4000K/ 5000K	29000lm		
LMFL-240W	240W	4000K/ 5000K	34800lm		
LMFL-300W	300W	4000K/ 5000K	43500lm		

Accessories 配件



Slip-fitter



Square/ Round Pole Mount



Universal Mount

Light Distribution 光照分布

Type II

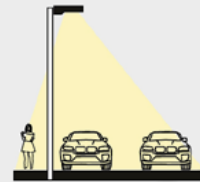

Type III

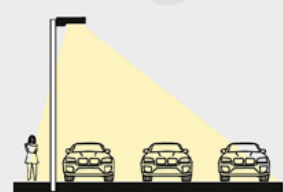

Type IV



Type V

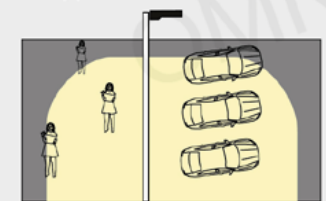

Dimension 產品尺寸

WATT 瓦數	Dimension 尺寸 (mm)		
	A	B	C
100W	349	300	82
150W	349	300	82
200W	436	340	82
240W	436	340	82
300W	442	380	85

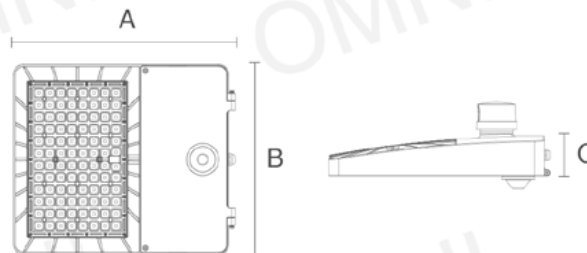

Emergency Li-ion Battery 應急鋰電池



- A variety of battery capacity with compact design specially fits for narrow space
電池容量選擇多且輕巧，方便應用於狹小空間
- Li-ion Battery has lower self-discharge rate than nickel battery
鋰電池自我放電較鎳電池低
- Comply with HKFSD Licensing and Certification Command [PPA/104(A)4th revision]
符合香港消防處牌照及審批總區[PPA/104(A)第四次修訂]



Certification for Safe Transport of Goods by Air

Certification for Safe Transport of Goods

Emergency Li-ion Battery Kit

應急鋰電池組



100% Power Emergency Li-ion Battery - 2hrs / 3hrs
100% 功率應急鋰電池 - 2小時 / 3小時

MODEL 型號	mAH (2 / 3hrs) 毫安 / 小時	WATT for Bulb (Ref.) 配燈瓦數(參考)
CRB-3-010010	LiR 11.1V 2200 / 4000mAh	Up to 10W
CRB-3-020020	LiR 11.1V 4400 / 6600mAh	Up to 20W
CRB-3-025025	LiR 11.1V 6600 / 8800mAh	Up to 25W

#Maximum Watt of LED Bulb: 150W 配燈最大可提供150W

30% Power Emergency Li-ion Battery - 2hrs / 3hrs
30% 功率應急鋰電池 - 2小時 / 3小時

MODEL 型號	mAH (2 / 3hrs) 毫安 / 小時	WATT for Bulb (Ref.) 配燈瓦數(參考)
CRB30-3010003	LiR 3.7V 2200 / 2600mAh	Up to 10W
CRB30-3040012	LiR 11.1V 2600 / 4400mAh	Up to 40W
CRB30-3060018	LiR 11.1V 4400 / 6600mAh	Up to 60W

#Maximum Watt of LED Bulb: 200W 配燈最大可提供200W

*Tailor-made output power is available for order 可訂制不同規格的功率

Accessories 配件

外置應急鋰電池盒 External Emergency Li-ion Battery Box



EBB-260/300



WBB-330 IP66

MODEL 型號	DIMENSION (mm) 尺寸 (L x W x H)
EBB-260	260 x 60 x 60
EBB-300	300 x 110 x 50
WBB-330 IP66	330 x 230 x 120

Emergency Li-ion Battery Kit 應急鋰電池組

T8 單管 / 雙管仿英式應急支架套裝
T8 Single / Double Tube Emergency Batten Set

- 可配 OMNI 3W-25W 電池 Compatible with OMNI 3W-25W battery



MODEL 型號	FT (SINGLE TUBE) 呎 (單管)	LED FIREPROOF GLASS TUBE 防火玻璃LED光管
T8E-F2	2ft	Comply with 符合 BS EN 60598-2-22:2014 850°C glowing/hot wire test
T8E-F4	4ft	
T8E-F5	5ft	

應急三防支架 Emergency Weatherproof Batten



MODEL 型號	FT 呎
T8W-F2	2ft
T8W-F4	4ft
T8W-F5	5ft

其他配套產品組合 Other Product Set

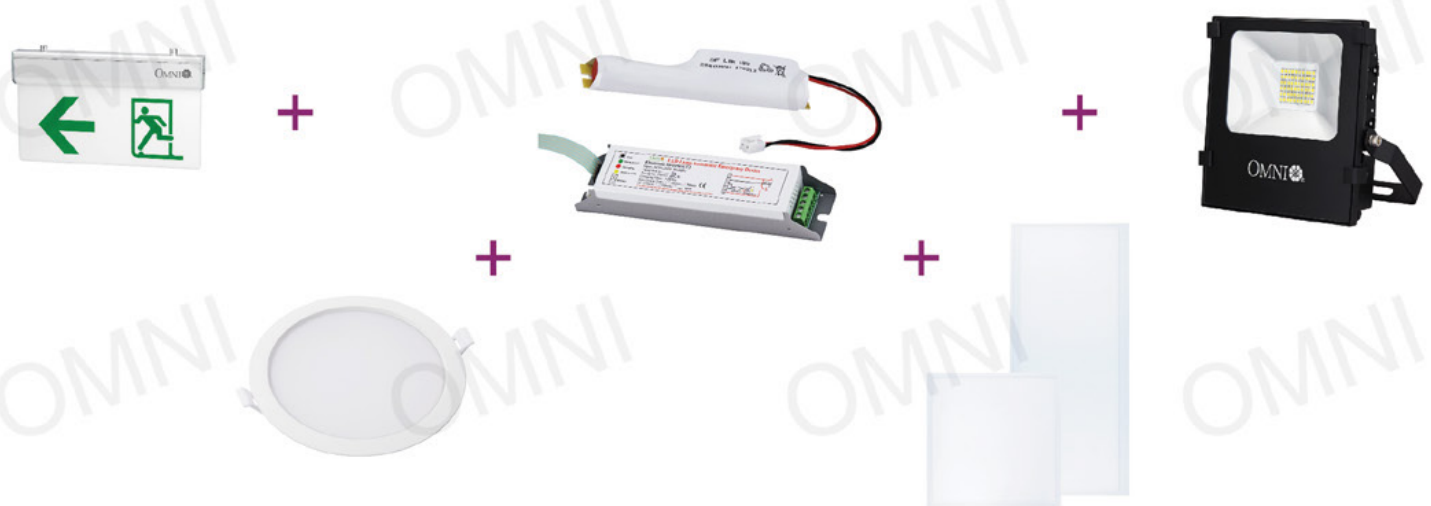

13A USB Safety Extension Sockets

13A USB 獨立開關安全拖板

-Safety standard complied to BS1363-2
通過英國安全標準BS1363-2

-Power cord conforms to EN50525 standard, not easy to be intenerated and distorted
電源線符合EN50525安全標準, 不易軟化及變形

-USB port conforms to EN62368 standard
USB通過EN62368安全標準

-1.25mm² three core wire
1.25mm² 三芯電線

-13A CTA-010 plug
13A 一體化插頭



3 USB Safety Extension Sockets

3位USB獨立開關安全拖板



MODEL 型號	SOCKET 插蘇位	USB CHARGER USB 充電位	CABLE LENGTH 電線長度	PACKING 包裝	DIMENSION (mm) 尺寸 (L x W x H)
UK033-10	3	3	10ft	12pcs/ctn.	288 x 67 x 26
UK043-10	4	3	10ft	12pcs/ctn.	338 x 67 x 26
UK053-10	5	3	10ft	12pcs/ctn.	397 x 67 x 26

Rated Voltage: 250V ~
Rated Current: 13A MAX
Rated Power: 3250W MAX
USB port total output: 5V=3.1A

13A USB Safety Extension Sockets

13A USB 獨立開關安全拖板

Features 特點



通過英國安全標準BS1363-2
Safety standard complied to BS1363-2



電源線符合EN50525安全標準, 不易軟化及變形
Power cord conforms to EN50525 standard,
not easy to be intererated and distorted



USB通過EN62368安全標準
USB port conforms to EN62368 standard



高品質合金塑料外殼, 耐壓、防潮、
耐高溫、阻熱高達750°C
PC alloy casting: max. fire resistance 750°C,
resistance to pressure & humidity



銀鍍合金觸點開關, 耐用、減低發熱火花
Silver alloy touch point switch, high
endurance and low heat elevation



設有兒童安全保護門
Children safety shutter

4 USB Safety Extension Sockets

4位USB獨立開關安全拖板



MODEL 型號	SOCKET 插蘇位	USB CHARGER USB 充電位	CABLE LENGTH 電線長度	PACKING 包裝	DIMENSION (mm) 尺寸 (L x W x H)
UK034-10	3	4	10ft	12pcs/ctn.	265 x 65 x 25
UK044-10	4	4	10ft	12pcs/ctn.	316 x 65 x 25
UK054-10	5	4	10ft	12pcs/ctn.	367 x 65 x 25
UK064-10	6	4	10ft	12pcs/ctn.	419 x 65 x 25

Rated Voltage: 250V ~
Rated Current: 13A MAX
Rated Power: 3250W MAX
USB port total output: 5V $\overline{\text{---}}$ 4.2A

13A Safety Extension Sockets

13A 獨立開關安全拖板

Features 特點



通過英國安全標準BS1363-2
Safety Standard complied to BS1363-2



電源線符合EN50525安全標準，不易軟化及變形
Power cord conforms to EN50525 standard, not easy to be interenerated and distorted



銀鍍合金觸點開關，耐用、減低發熱火花
Silver alloy touch point switch, high endurance and low heat elevation



高品質合金塑料外殼，耐壓、防潮、耐高溫、阻熱高達750°C
PC alloy casting: max. fire resistance 750°C, resistance to pressure & humidity



設有兒童安全保護門
Children safety shutter



LED 獨立開關指示燈
LED individual switch with neon indicator



13A 一體化插頭
13A CTA-010 plug

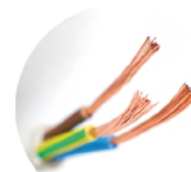

MODEL 型號	SOCKET 插蘇位	CABLE LENGTH 電線長度	PACKING 包裝	DIMENSION (mm) 尺寸 (L x W x H)
UK020-9	2	9ft	12pcs/ctn.	174 x 63 x 26
UK030-9	3	9ft	12pcs/ctn.	234 x 63 x 26
UK040-9	4	9ft	12pcs/ctn.	293 x 63 x 26
UK050-9	5	9ft	12pcs/ctn.	352 x 63 x 26
UK060-9	6	9ft	12pcs/ctn.	411 x 63 x 26

Rated Voltage: 250V ~
Rated Current: 13A MAX
Rated Power: 3250W MAX

13A British Standard Sockets

13A 英標插頭

13A British Standard Sockets

BS
1363-1



13A 一體化插頭
Model 型號: CTA-010



13A 標準插頭
Model 型號: UKP-001



13A 標準插頭 (電木)
Model 型號: UKP-003



13A 大開關插頭
Model 型號: UKP-501



13A 大開關帶燈插頭
Model 型號: UKP-502



13A 小開關插頭
Model 型號: UKP-301



13A 小開關帶燈插頭
Model 型號: UKP-302



3A 轉換插頭
Model 型號: UKP-202



USB 充電插頭
Model 型號: USB-214



1.25mm² 三芯電線
Model 型號: UKBS-002

BS
1363-3

IEC
60950
Max 2.1A

Universal Travel Adapter (For Export Only)

環球旅行轉插 (只供出口)

Universal Travel Adapter



禮品及贈物

可供絲印商標

Logo printing service - available

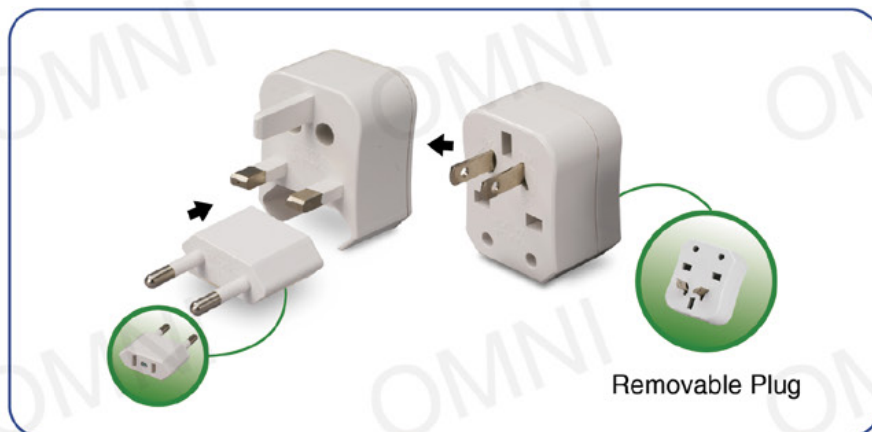

Removable Plug

MODEL 型號	RATED INPUT VOLTAGE 額定輸入電壓	PACKING 包裝
WUA-004	3A 250V-6A125V-50/60Hz	120pcs/ctn.

Universal Travel Adapter with USB



禮品及贈物

可供絲印商標

Logo printing service - available



Max 2.1A

MODEL 型號	RATED INPUT VOLTAGE 額定輸入電壓	PACKING 包裝
WUA-005	3A 250V-6A125V-50/60Hz	60pcs/ctn.

			Europe, Australia, New Zealand, Asia, Indonesia, Philippines, Vietnam, South Korea, Africa				USA, Canada, Japan, Taiwan, Caribbean Islands, Part of South America
			China, Mongolia, Southeast Asia, Thailand, Australia, New Zealand, Part of South America				United Kingdom, Ireland, Singapore, Malaysia, Hong Kong, Macau, Middle East

LED Other Products LED 其他產品

LED Red Round Bulb 紅球膽



Model 型號: LRR-1.5W

LED Red Candle Bulb 紅蠟燭膽



Model 型號: LMR-0.5W

LED TRIO 3 Colors Flat Lamp TRIO 三色簡約頂燈



Model 型號:
LFE27-22W-TRIO/
LFB22-22W-TRIO



Model 型號:
LFE27-30W-TRIO

LED High Power Pillar Bulb 高效能柱燈



Model 型號:
LM65E27-15W-DL/ LM65E27-15W-WW
LM65E27-20W-DL/ LM65E27-20W-WW



Model 型號:
LMB120E27-45W-DL/
LMB120E27-45W-CW

LED Other Products

LED 其他產品

LED GX53 Cabinet Lamp 櫥櫃燈



Model 型號:
LGX53-7W-DL/ LGX53-7W-CW/ LGX53-7W-WW

LED Strip Light 燈帶



Model 型號:
LSDC-8W-DL/ LSDC-9.6W-WW

LED Downlight 筒燈



Model 型號: LLRC-10WW

LED Spotlight 射燈



Model 型號: LG4-2W-WW

LED Panel Light 平板燈



Model 型號: LP330-18W-DL

LED Slim Panel Light 纖巧平板燈



Model 型號: LSP-18W-DL/ LSP-36W-DL

LED Other Products LED 其他產品

LED Weatherproof Slim Flood Light 纖巧防水泛光燈



Model 型號:

LLFL-10WDL/ LLFL-20WDL/ LLFL-30WDL/ LLFL-40WW/ LLFL-40WCW/
LLFL-100WDL/ LLFL-100WW/ LLFL-150WDL/ LLFL-150WW

GARDIEN LED USB Mosquito Lamp GARDIEN LED USB 可攜式滅蚊燈



Model 型號: MSL-0040

MOSKITOFF LED Dual-Bands Mosquito Lamp MOSKITOFF LED 雙段變頻滅蚊燈



Model 型號: MSL-0060

LED Other Products

LED 其他產品

ÉNERGIE LED 無線摺疊充電護眼檯燈

ÉNERGIE LED Wireless & Powerbank Eye Protection Table Lamp



Model 型號: AEL-300

GADGET LED 充電無線護眼檯燈

GADGET LED Wireless Eye Protection Table Lamp



Model 型號: DEL-0063

LITE BREEZE LED 送風無線護眼檯燈 (藍/白)

LITE BREEZE LED Bladeless Fan & Wireless Eye Protection Table Lamp (Blue/ White)



Model 型號: DEL-9031

Symbol Index 標籤索引

The International Electrotechnical Commission (IEC) Standard
國際電工委員會認證

The world's leading organization that prepares and publishes International Standards for all electrical, electronic and related technologies
全球領先的認證組織，為所有電器、電子及相關技術制定及出版國際標準

- | | | | |
|-------------------------|--|---|--|
| <p>IEC 60061</p> | <p>Lamp caps and holders together with gauges for the control of interchangeability and safety.
燈頭、燈座及量度器互換性和安全控制。</p> | <p>IEC 62838</p> | <p>For general lighting services with supply voltages not exceeding 50V a.c.r.m.s. or 120V ripple free d.c. - safety specifications.
適用於需搭配外部控制器提供低電壓輸入電源之LED燈泡，而外部控制器分為低頻(50Hz/60Hz)及高頻(AC electronic)兩種。</p> |
| <p>IEC 60598</p> | <p>General requirements for luminaires, incorporating electric light sources for operation from supply voltages up to 1000V.
對於一般燈具的要求，及對供電電源不超過1000V的特定類型燈具詳細要求。</p> | <p>IEC 62368</p> | <p>Standard applies to equipment intended to supply and receive operating power through communication cables or ports. It covers particular requirements for circuits that are designed to transfer DC power from a power sourcing equipment (PSE) to a powered device (PD).
適用於通過通信電纜或端口提供和接收工作電源的設備，並涵蓋設計用於將直流電從供電設備(PSE)傳輸到受電設備(PD)的電路。</p> |
| <p>IEC 60950</p> | <p>Applicable to mains-powered or battery-powered information technology equipment with a rated voltage not exceeding 600V.
適用於主電源或電池電源資訊產品(含商業電子設備)及其週邊產品，且額定電壓低於600V。</p> | <p>IEC 62680</p> | <p>Standard for power delivery system covering all elements of a USB system including: Hosts, Devices, Hubs, Chargers and cable assemblies.
涵蓋USB系統所有元件的供電系統標準，包括：主機、驅動器、集線器、充電器和電線組件。</p> |
| <p>IEC 61347</p> | <p>Particular safety requirements for electronic controlgear.
電子控制裝置的特殊安全規範。</p> | <p>BS 1363-1</p> | <p>13A plugs, socket-outlets, adaptors and connection units. Specification for rewirable and non-rewirable 13A fused plugs.
13A 插頭、插座、適配器和連接單元的安全標準 - 第1部分：可拆線和不可線13A帶保險絲插頭規格。</p> |
| <p>IEC 62031</p> | <p>LED modules for general lighting - Safety specifications.
LED 模塊用於普通照明 - 安全規範。</p> | <p>BS 1363-2</p> | <p>13A plugs, socket-outlets, adaptors and connection units Part 2: Specification for 13A switched and unswitched socket-outlets.
13A 插頭、插座、適配器和連接單元的安全標準 - 第2部分：13A開關和不帶開關插座規格。</p> |
| <p>IEC 62321</p> | <p>Electrotechnical products - Determination of levels of six regulated substances (lead, mercury, cadmium, hexavalent chromium, polybrominated biphenyls, polybrominated diphenyl ethers).
用於檢測電子設備中六種受管制物質的含量，包括鉛(Pb)、汞(Hg)、鎘(Cd)、六價鉻(Cr(VI))、多溴聯苯(PBB)和多溴二苯醚(PBDE)。</p> | <p>BS 1363-3</p> | <p>13A plugs, socket-outlets, adaptors and connection units Part 3: Specification for adaptors.
13A插頭、插座、適配器和連接單元的安全標準 - 第3部分：適配器規格。</p> |
| <p>IEC 62471</p> | <p>Photobiological safety of lamps and lamp systems.
燈和燈系統的光生物安全性。</p> |  | <p>No ultraviolet and infrared rays.
不含紫外線及紅外線。</p> |
| <p>IEC 62493</p> | <p>Assessment to of lighting equipment related to human exposure to electromagnetic fields.
用以評估人體暴露在照明設備所造成的空間電磁場允許值標準。</p> |  | <p>Restriction of the use of certain hazardous substances.
禁止使用數種有害物質。</p> |
| <p>IEC 62560</p> | <p>Safety and interchangeability requirements intended for domestic and similar general lighting, which rated up to 60W and range from 50V up to 250V.
用於家庭及類似環境的普通照明安全性和互換性要求，此燈具需達60W，額定電壓大於50V至250V。</p> |  | <p>WEEE Recycling Logo - prevent careless disposal of electrical products.
歐盟WEEE回收標誌 - 禁止消費者隨意丟棄廢電子電機產品。</p> |
| <p>IEC 62776</p> | <p>Double-capped LED fluorescent lamps - safety specifications.
雙端LED光管 - 安全規範。</p> |  | <p>Dimmable bulb (appropriate dimmer is needed).
可調光燈膽(需搭配適當調光器)。</p> |
| <p>IEC 62778</p> | <p>The standard for assessment of blue light hazard to light sources and luminaires.
針對光源和燈具所發出的藍光危害評估標準。</p> | | |



Non-dimmable bulb.
非調光燈膽。



European Conformity Mark - Standard for the product that complies with the essential requirements of the relevant European health, safety and environmental protection legislation.

歐洲統一標誌 - 產品符合歐洲健康、安全及環保法規的基本標準。



Underwriters Laboratories Inc., a nonprofit inspection agency in the United States. It mainly regulates the safety of machinery, electronic and electrical equipment and materials to protect customers from any accidents such as fires.

Underwriters Laboratories Inc. 是美國的非營利性檢查機關。主要對機械、器材，如電子及電器產品、材料的安全性進行監督管理，以防止火災等事故危害消費者生命安全。



PSE (Product Safety of Electrical Appliance & Material) is a compulsory certification for electrical products imported to Japan.

PSE (Product Safety of Electrical Appliance & Material) is 是電氣產品進入日本市場的強制性驗證制度。



Accredited by the Joint Accreditation Service of Australia and New Zealand (JAS-ANZ) as a third party certification body to issue of Certificates of Approval for declared and non-declared electrical equipment that has proven to comply with the safety requirements of the applicable Australian Standard. 經澳洲和紐西蘭聯合認證體系(JAS-ANZ)核准的協力廠商認證機構，有資格給強制認證電氣設備和非強制認證電氣設備頒發認證證書，證明這些設備符合現行的澳洲標準規定的安全要求。



Safety certification logo customized for component products by TüV, which is extensively recognized by Germany and Europe.

德國TüV專為元器件產品定制的一個安全認證標誌，在德國和歐洲得到廣泛接受。



Material Safety Data Sheet(MSDS) is a technical document which provides detailed and comprehensive information on a controlled product related to, health effects of exposure to the product, hazard evaluation related to the product's handling, storage or use and emergency procedures.

化學品安全說明書，是用來闡明產品的理化特性，例如：接觸產品對健康的影響、產品處理、儲存或使用的險危險評估、安全使用及洩漏緊急救護處置。



The IECCEB Scheme is a multilateral agreement between participating countries and their resident certification organizations. CB certification is an international safety certification of electrical and electronic products.

IECEE CB計劃是參與國與其居民認證組織之間的多邊協議。CB認證是電氣和電子產品的國際安全認證。



Electromagnetic compatibility test is the comprehensive assessment of the interference (EMI) and anti-interference ability (EMS) of electronic products in the electromagnetic field. It can evaluate the impact of electromagnetic radiation generated by electrical products on human, public power grid and others.

電磁相容測試，指的是對電子產品在電磁場方面干擾大小(EMI)和抗干擾能力(EMS)的綜合評定，目的是檢測電器產品所產生的電磁輻射對人體、公共電網以及其他正常工作之電器產品的影響。



Standard for protection against solid objects and liquids. 對抵禦固體及液體程度之標準。

First Digit - Solids 第一個數字 - 固態微粒



"5"

Protected against dust limited ingress. Prevent ingress of dust sufficient to cause harm.

灰塵有限度進入，但灰塵進入的數量不會影響設備的正常運作。



"6"

Totally protected against dust. 完全防止灰塵進入。

Second Digit - Liquids 第二個數字 - 液體

"4"

Protected against water splashed from all directions, limited ingress permitted.

可抵受從任何方向射來的水花。

"5"

Protected against low pressure jet of water from all direction and limited ingress permitted.

抵受低壓水柱由任何方向噴射並允許有限進入。

"6"

Protected against strong jets of water, limited ingress permitted.

可抵受來自所有方向的高壓水柱噴射。

Average lifetime 平均壽命：

Computed at 5 hours per day when used in proper condition. 在正確環境使用下，每天使用5小時計算。

Authorized Distributor



YATAI INTERNATIONAL CORPORATION

Yatai Tower, 2673-C Rafael Alunan Street,
Interior Road, Malate, Manila, Philippines

Tel.: +63-2-567-0000

Fax: +63-2-567-2342

Email: info@omni.net.ph

Website: www.omniphilippines.com.ph

OMNI ELECTRICAL (HK) CO., LTD

Room D, 18/F, Block 1, Vigor Industrial Building,
49-53 Ta Chuen Ping Street, Kwai Chung, New Territories, Hong Kong

Tel: +852-2305-4478

Fax: +852-3971-0647

Email: sales@omni-hk.com

Eshop: www.omnihongkong.com

Website: www.omni-hk.com

OMNI ELECTRICAL AND LIGHTING (AUSTRALIA) PTY., LTD.

17 Lacey St., Croydon, Vic 3136, Australia

Tel.: +61-1300-333-001

Fax: +61-1300-333-002

Email: sales@omni-au.com

Website: www.omni-au.com

YATAI (CHINA) ELECTRICAL CO., LTD

5th Floor, No.5 Building,
Guanyinshan International Business Park,
Siming District, Xiamen, China

Tel.: +86-592-5058882

Fax: +86-592-5033882

Email: lighting@yataichina.com

Website: www.omni-china.com